



RGMAT E G60

Installation and Operation Manual
**RegulusRGMAT E G60 LOAD UNIT with UPM 3, insulated
for heating systems**

EN

1. Introduction

RegulusRGMAT E G60 Load Unit makes boiler installation quicker as it contains all important components needed for boiler circuit circulation and boiler protection against low-temperature corrosion. It is designed to be installed directly on a boiler return piping. The min. distance of the pipe axis from a wall is 100 mm to enable insulation removal if needed.

This Load Unit is intended for hydronic fireplaces and solid-fuel boilers.

2. RGMAT E G60 Description

RGMAT E G60 keeps the temperature at the boiler inlet above the flue gas condensation temperatures, which prevents so called low-temperature corrosion of the boiler combustion chamber. This limits condensation and boiler tarring significantly, the efficiency of fuel combustion increases and service life of the boiler is extended.

Main Features	
Function	maintaining a minimum inlet temperature into a boiler (fireplace) through a load valve
Application	Load Unit for solid-fuel boilers and fireplaces; it prevents low-temperature corrosion and boiler (fire) fouling
Description	consists of a UPM3 FLEX AS pump, ball valves with union nuts, TSV3B valve (with automatic bypass balancing), thermometer, insulation
Working fluid	water; water/glycol mixture (max. 1:1) or water/glycerine mixture (max. 2:1)
Installation	on boiler return piping, min. distance of the pipe axis from a wall is 100 mm

Codes	max. boiler output
19083 for opening temperature 45 °C	max. 46 kW
19090 for opening temperature 50 °C	max. 42 kW
19086 for opening temperature 55 °C	max. 36 kW
19092 for opening temperature 60 °C	max. 32 kW
19089 for opening temperature 65 °C	max. 26 kW
19091 for opening temperature 70 °C	max. 22 kW

RGMAT E G60 Technical Data	
Fluid working temperature	5 - 95 °C
Max. working pressure	6 bar
Min. working pressure	0.5 bar
Max. ambient temperature	5 - 40 °C
Max. relative humidity	80 %, non condensing
Load valve control range	$t_{\text{valve opening}} + 5 \text{ °C}$
Valve Kvs (A→AB direction)	6.2 m ³ /h
Valve Kvs (B→AB direction)	4.4 m ³ /h
Power supply	230 V, 50 Hz
Insulation material	EPP RG 60 g/l
Overall dimensions	325 x 140 x 220 mm
Total weight	3.25 kg
Connections	3x G 1" F

Accessories	
Bypass with float non-return valve	code 16126

3. RGMAT E G60 Connection Diagram

Possible Connection Example I.

The diagram shows a typical connection of a solid-fuel boiler, thermal store and a heating circuit (with a recommended CSE MIX W pump station - not included in supply). If the boiler is also used for DHW heating, it is recommended to install also CSE OTS ZV W pump station (not included in supply).

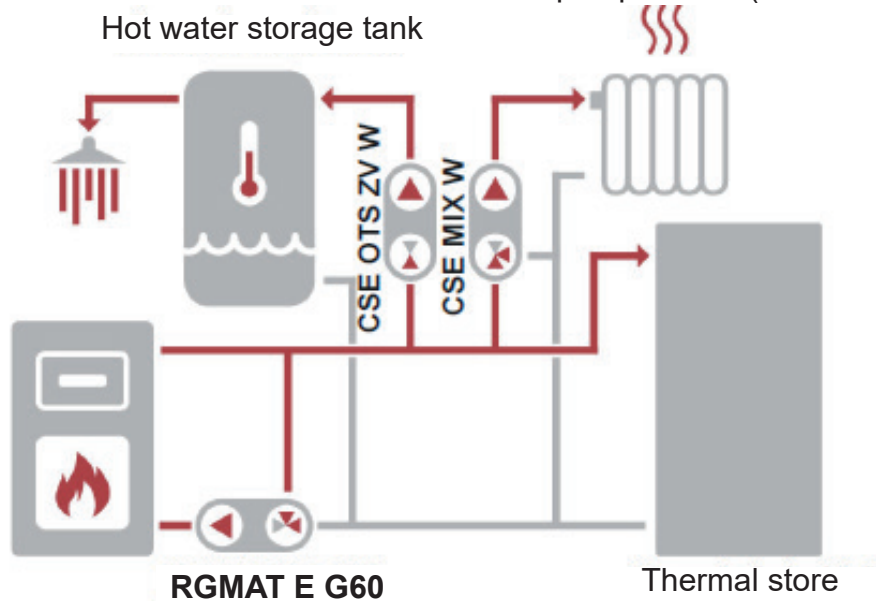

Possible Connection Example II.

The diagram shows a typical connection of a solid-fuel boiler, combination thermal store (permitting DHW heating) and a heating circuit (with a recommended CSE MIX W pump station - not included in supply).

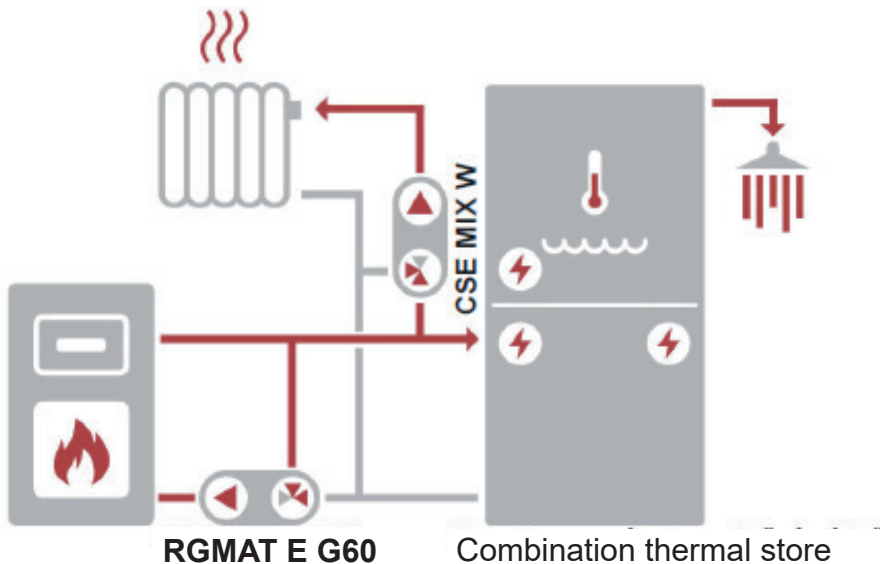

Install the Load Unit respecting the following instructions:

Connect the boiler inlet piping to the Load Unit outlet marked **AB**. Connect the return line from the heating system to the **A** inlet, and the outlet pipe from the boiler to the **B** inlet via a T-piece. Take care to install shut-off valves and filter where necessary to avoid draining the whole system for valve cleaning or replacing the thermostatic element.

When the connecting pipes are not arranged or sloped properly, the load valve may get blocked by air inside. This may hinder or even disable its operation.

Always respect valid rules and boiler manufacturer's data during installation.

4. Function description of a TSV3B valve

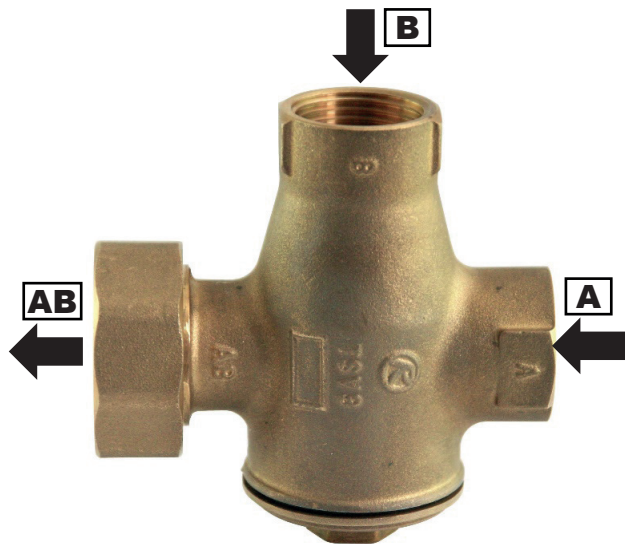

TSV3B TSV5B 6/4Mx5/4F load valve is fitted with an integrated thermostatic insert that will close the **A** inlet (from a heating system), if the return water temperature to the boiler (**AB** outlet) is lower than the opening one. As soon as the opening temperature is reached, the thermostat starts opening the **A** inlet slowly and mixing the cold return water with the hot water from the boiler flow (**B** inlet) with the aim to reach the opening temperature in the return pipe (**AB** outlet).

At the same time, the valve closes the **B** inlet, limiting so the hot water flow coming from the bypass till its complete tight closure. Thanks to this, no balancing valve is needed. The load valve is made of brass, element and plug seals are in EPDM, cone seal is made of NBR.

Technical Data	
Valve opening temperature	depending on the thermostatic element
Control range	$t_{\text{valve opening}} + 5\text{ °C}$
Connections	2x G 1" F, 1x G 6/4" union nut
Nominal inner diameter	DN 25

Materials	
Housing, cone and plug	brass
Spring	stainless steel
Element and plug seal	EPDM
Cone seal	NBR

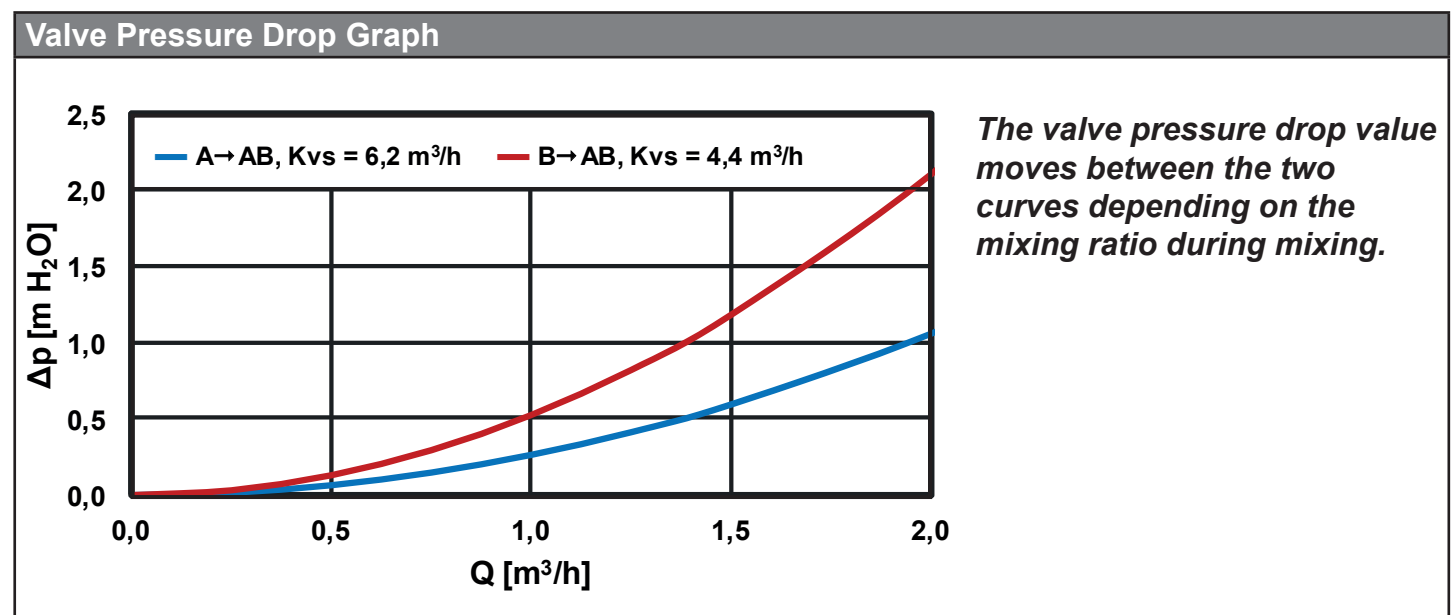

5. UPM3 FLEX AS 25-60 180 Pump

Design

Wet-running circulation pump with G 6/4" M connection.

Electrical Data	
Power supply	230 V, 50 Hz
Power consumption (min./max.)	2/42 W
Current (min./max)	0.04/0.40 A
IP rating	IP44
Max. speed	5288 rpm
Weighted average power	≤ 20 W
Energy Efficiency Index	≤ 0,20 by EN 16 297/3
Motor protection	not needed



Pump control

The circulation pump can be controlled by an external PWM signal (profile for use in heating systems) or without a PWM signal by selecting a pump performance curve.

A maximum curve of a pump working range can be defined.

- with PWM signal the pump speed changes with the signal value up to the maximum of the selected curve
- without PWM signal the pump runs at the max. speed according to the selected curve

Performance Curves

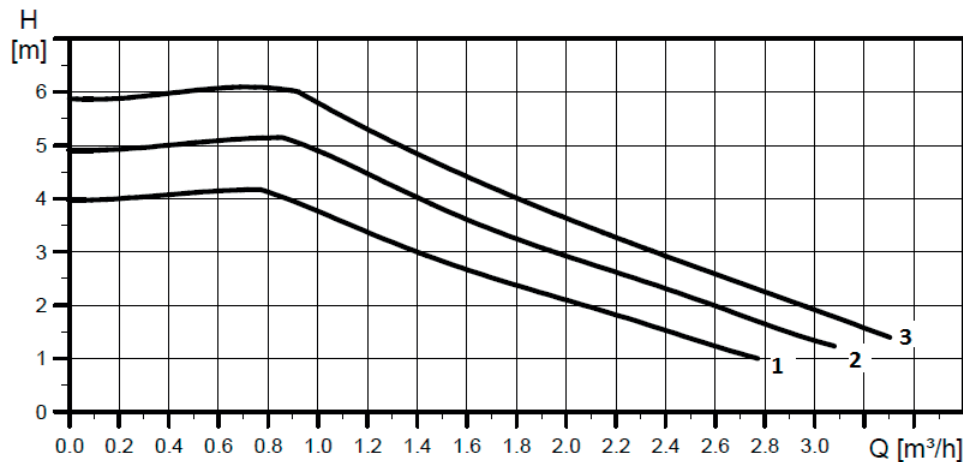

Curve	Max. H (upper graph)	Max. P ₁ (lower graph)
1	4 m	25 W
2	5 m	34 W
3	6 m	42 W

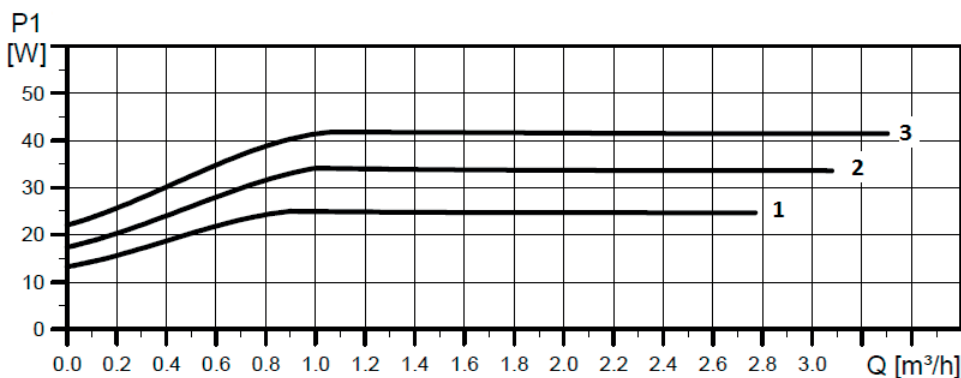

Performance display

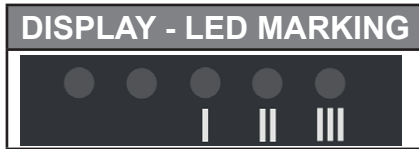

The LED marking is further omitted for better clarity.

DISPLAY	PERFORMANCE CURVE	STATE	Max. H (upper graph)
	1	LOW PERFORMANCE	4 m
	2	MEDIUM PERFORMANCE	5 m
	3	HIGH PERFORMANCE	6 m

WARNING: LEDs may be mirrored, depending on the specific pump type.

GREEN LED FLASHING FREQUENCY	PWM SIGNAL RECEPTION
1 flash per second	NO
12 flashes per second	YES

When switched on, the pump runs at factory settings or the last setting. The display shows the current pump performance.

Setting selection for UPM3

To select your desired setting, press the button repeatedly until you find the setting you need (see the figure above). If you pass the desired setting, you have to go one more round until it appears again.

Error Display

DISPLAY	CONTROL MODE
	Seized pump
	Too low power supply voltage
	Electric fault

Permissible and prohibited pump positions

Prohibited positions

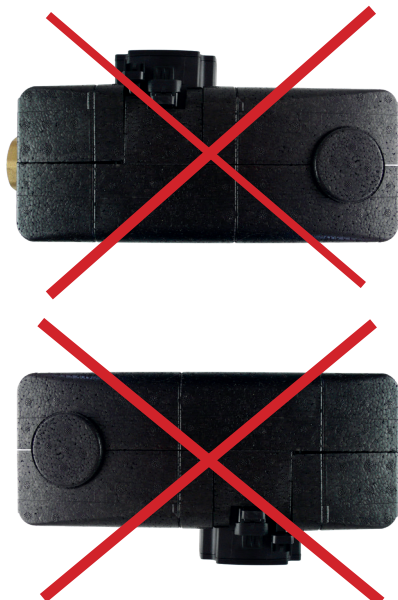

Permissible positions



Pump wiring

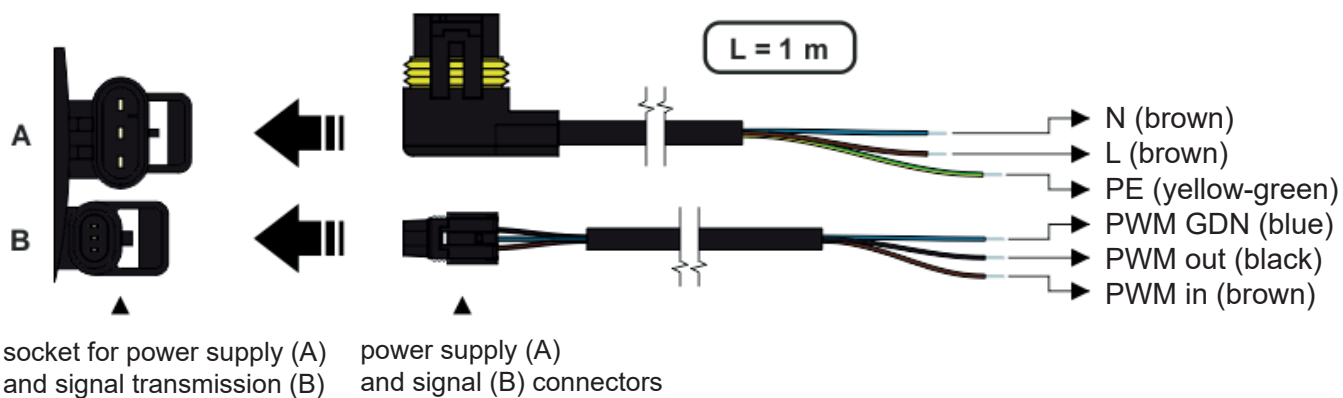

6. Installation options

This Load Unit comes in the version for horizontal installation to the right of a boiler. However, it can be installed also into vertical piping or horizontally to the left of a boiler. When being installed horizontally to the left of a boiler, the Load Unit needs to be turned by 180° and the TSV3B valve turned as shown in the pics below.

