



# HEAT RECOVERY VENTILATION



## Overview of HRV units, accessories and air ducts

## HEAT RECOVERY VENTILATION

A heat recovery ventilation system is intended for optimum air exchange in a building with minimum heat loss from ventilation. Thermal loss caused by ventilation in current family houses ventilated by micro-ventilation or semi-opened windows makes up to 40% of the total heat loss of a building. Heat recovery ventilation has become an integral part of recent ventilation systems. Thanks to heat transfer between the outgoing and incoming air, a house is ventilated sufficiently without suffering from high heat loss.

More and more strict requirements regarding the airtightness of the building envelope and other construction elements bring about insufficient air exchange inside the buildings, causing problems with dampness, mould and growth of microorganisms like e.g. mite, which often leads even to health problems. These problems cease when a ventilation system is installed. The building is ventilated mechanically, with different intensity at different times of day. Permanent ventilation is ensured this way even at times when nobody is present.

A heat exchanger has become a crucial component in recent Heat Recovery Ventilation (HRV) systems. It transfers heat from the outgoing stale warm air to the incoming fresh cold air.

However, it shall be noted that this is no heating appliance, just a ventilation unit ensuring the necessary air exchange. For this reason the building in question shall be equipped with an independent heating system and a heat source. HRV systems for detached houses require neither a detailed design nor complicated calculations, the principle and design of a Heat Recovery Ventilation system is very simple. Just a couple of principles shall be maintained during design and installation that are described on the following pages.

### WORKING PRINCIPLE

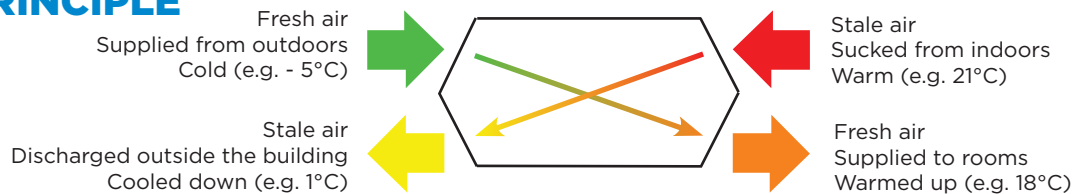

Fresh air is sucked into the HRV unit either through an outer wall or through a vent duct termination in a roof. The incoming fresh air flows into the HRV unit where it is preheated in a heat exchanger by heat taken from the warm stale exhaust air.

The preheated fresh air is distributed to individual rooms like bedrooms, living room, study etc. while the stale air is extracted from wet rooms like a toilet, bathroom or kitchen. This way the incoming fresh air flows through the entire house and adequate whole house ventilation is secured. It is not advisable to connect a kitchen hood to such a ventilation system because there is a risk of air ducts becoming contaminated with impurities coming from cooking.

The cooled stale air is discharged either through an outer wall or through a roof, however a minimum distance from the intake orifice shall be secured. Single room HRV units are installed in a peripheral wall, so no air ducts are needed.

### A WHOLE-HOUSE VENTILATION SYSTEM

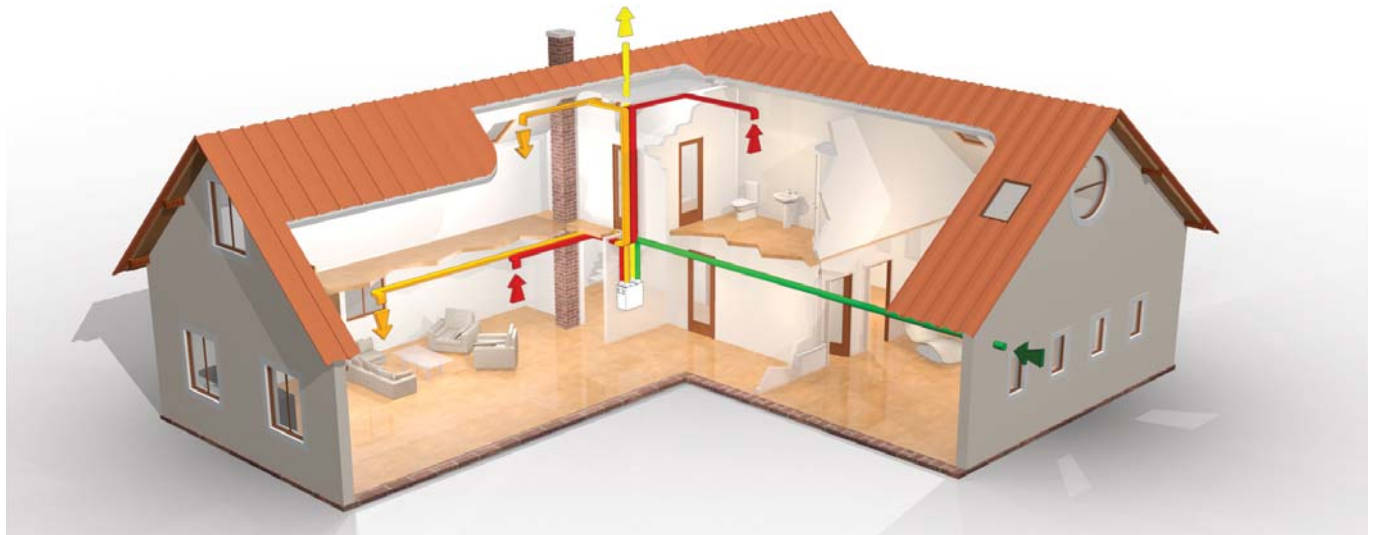

## SYSTEM DESIGN

HRV system design is simple, requiring no complicated calculations.

First of all, a suitably sized unit shall be selected depending on the size of the building and number of inhabitants. Sentinel Kinetic B, Sentinel Kinetic Advance or Horizontal 200ZPH are the best for single-family houses with living area up to 200 sqm.

**Sentinel Kinetic B Plus**



for **family homes up to 350 sqm**  
performance: **490 m<sup>3</sup>/h**  
spigot diameter: **150 mm**

**Sentinel Kinetic Advance**



for **family homes up to 300 sqm**  
performance: **414 m<sup>3</sup>/h**  
spigot diameter: **125 mm**

**Sentinel Kinetic B**



for **family homes up to 200 sqm**  
performance: **275 m<sup>3</sup>/h**  
spigot diameter: **125 mm**

**Sentinel Kinetic Horizontal**



for **family homes and flats up to 120 sqm**  
performance: **168 m<sup>3</sup>/h**  
inlets/outlets **240x60 mm**

Then, the duct routes and positions of air disks shall be considered.

Ideally, both supply and exhaust air disks should be located in a ceiling. If this is not possible, air can be supplied through grilles above the floor. In any case, stale air intake shall not be located less than 150 cm above floor.

Air ducts are routed from the unit to individual rooms.

Regulus ventilation systems use several types of air ducts:

- round flexible aluminium ducts,
- rigid rectangular plastic ducts 60x200 mm,
- flexible highly resistant PE ducts with antibacterial treatment,
- round plastic ducts,
- round EPP ducts.

For newly built houses, consult the ducting layout with your building designer.

In case of a house remodelling, our engineers are ready to help you with ducting design.

**ROUND FLEXIBLE ALUMINIUM DUCTS**

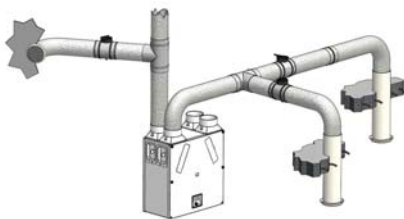

**ROUND FLEXIBLE PE DUCTS**

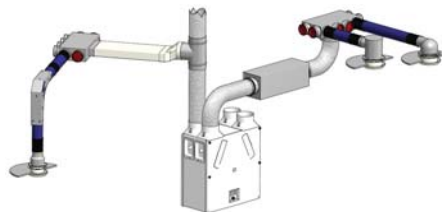

**RECTANGULAR PLASTIC DUCTS**

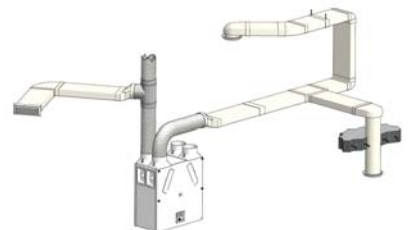

# CENTRAL HRV UNITS

## Sentinel Kinetic Advance

Sentinel Kinetic Advance S and SX Central HRV Units are HRV units of a new generation that permit respecting individual living mode in the building and the lifestyle of the user. They are designed for continuous ventilation of family homes of living area up to 300 sqm, bringing maximum comfort for the user and an easy installation. The most advanced materials are used for the production.

Advance HRV Units are equipped with an integrated digital controller with a touchscreen, automatic bypass, humidity sensor, a condensate discharge point, enabling also WiFi connectivity. For the most comfortable ventilation, also carbon dioxide sensors, humidistats, PIR sensor and similar can be added.

The inner room of the units is fitted with high-quality thermal insulation which permits the units to be installed also in unheated spaces (e.g. an attic) without suffering from energy losses.

The unit can be controlled via the integrated backlit touchscreen, via WiFi connection or through a master controller. The touchscreen can be fitted directly on the unit, or connected via a docking station. The WiFi connection enables the user immediate access to the unit, its commissioning, configuring and monitoring of the ventilation mode. Then the unit can be controlled and its settings modified using a smartphone or tablet. Two G3 filters are integrated in Kinetic Advance units for the sake of a healthy climate inside the building. When even a better filtration is needed, F5 filters can be added downstream from the G3 filters that will secure clean air even in locations with polluted air.

Due to the high efficiency of the unit, the heat exchanger could suffer from ice formation under extreme frost. For this reason the unit is equipped with an automatic defrost function. A frozen heat exchanger can be also prevented by installing an air duct heater in the intake air duct – see the chapter Air duct heaters. A cooler outdoor air can be used to help cool the building via the integrated summer bypass.

### PERFORMANCE MODES

5 preset performance modes are available in the unit. It is possible to program a different ventilation intensities for different day periods and for separate days of a week, purge intervals and silent hours for night operation. Maintaining optimum relative humidity inside the building is ensured by automatic proportional air flow increase based on the measurements from an integrated humidity sensor. The integrated timer function in the unit will also ensure sufficient room ventilation with the possibility of relative humidity boost.



### TECHNICAL DATA

#### PERFORMANCE DATA

Max. air flow rate *	414 m <sup>3</sup> /h
Heat recovery efficiency	max. 93%
Energy Efficiency Class	A+

\*flow rates for specific installations shall be modified by performance diagrams

#### ACOUSTIC DATA

Sound level (at 3m distance)	15.5 dB(A) for low air flow 34 dB(A) for high air flow
---------------------------------	---

### DIMENSIONS

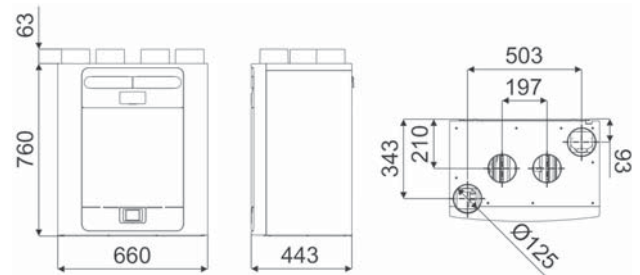

### MODELS

Sentinel Kinetic Advance S  
**Code: 16487**

Sentinel Kinetic Advance S ENT  
**Code: 17601**

Sentinel Kinetic Advance SX  
**Code: 16488**



Compared to the S type, the S ENT unit is equipped with an enthalpy heat exchanger that recovers not only heat but also humidity.



Compared to the S type, the SX unit is equipped with a WiFi module and offers constant volume flow control.

# CENTRAL HRV UNITS

## Sentinel Kinetic B

A whole-house heat recovery ventilation unit with integrated summer by-pass, designed for ventilation of family homes of living area up to 200 sqm.

An integrated air bypass permits air to bypass the heat exchanger in the summer. Its control is automatic, based on both the outdoor and indoor temperatures.

The unit control is very simple, different ventilation intensity can be programmed for different times. It shall be installed on the wall in a utility room or on the floor in the attic.

The unit is fitted with a condensate discharge point that needs to be connected to a sanitary sewer.

The unit involves replaceable G3 class air filters (for fine dust).

As a result of the unit's high efficiency, during periods of extreme frost the heat exchanger might suffer from freezing; for this reason the unit is equipped with an automatic defrosting function. The heat exchanger freezing can be prevented by installing an air duct heater on the intake air duct – see the Air Duct Heaters chapter.

A compact size and a very low noise level are the big advantages of this unit.

**Code: 10176**

### PERFORMANCE MODES

3 performance modes (speeds) are preset in the unit in relation to the space to be ventilated. Preset values can be changed freely. Switching between low and medium speed modes is automatic following the preset time program. High speed mode (boost) can be switched on either periodically, or by schedule, or by pressing a key. The boost mode start can be also automatic, e.g. by turning on the light in toilet.



### TECHNICAL DATA

#### PERFORMANCE DATA

Max. air flow rate *	275 m <sup>3</sup> /h
Heat recovery efficiency	max. 92%
Energy Efficiency Class	A
Low air flow	20 % (preset)
Medium air flow	30 % (preset)
High air flow	50 % (preset)
Purge	100%

\*flow rates for specific installations shall be modified by performance diagrams

#### ACOUSTIC DATA

Sound level (at 3m distance)	20 dB(A) for medium air flow
	36 dB(A) for high air flow

### DIMENSIONS

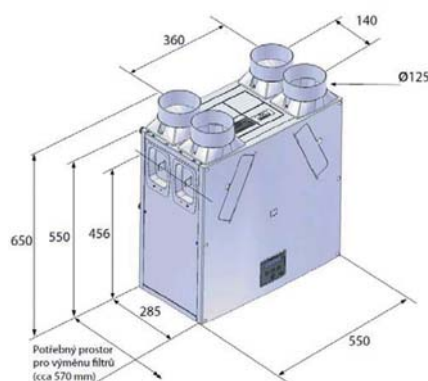

### ACCESSORIES

The inbuilt control panel permits connection of external control elements, e.g. a humidity sensor or a carbon dioxide sensor. A remote control panel can be connected as well which is suitable in installations where the unit is located at a not easily accessible place.

#### Air flow settings with respect to the total floor area of ventilated rooms.

Max. ventilated room		Low air flow		Medium air flow		High air flow (boost)	
living area	space volume	setting	[m <sup>3</sup> /h]	setting	[m <sup>3</sup> /h]	setting	[m <sup>3</sup> /h]
80 m <sup>2</sup>	200 m <sup>3</sup>	25%	40	40%	70	60%	130
100 m <sup>2</sup>	250 m <sup>3</sup>	30%	50	50%	100	70%	160
120 m <sup>2</sup>	300 m <sup>3</sup>	35%	60	60%	130	80%	200
150 m <sup>2</sup>	375 m <sup>3</sup>	40%	70	70%	160	100%	240



# CENTRAL HRV UNITS

## Sentinel Kinetic B Plus

A whole-house heat recovery ventilation unit with integrated summer by-pass, designed for ventilation of family homes of living area up to 350 sqm.

An integrated air bypass permits air to bypass the heat exchanger in the summer. Its control is automatic, based on both the outdoor and indoor temperatures.

The unit control is very simple, different ventilation intensity can be programmed for different times. It shall be installed on the wall in a utility room or on the floor in the attic.

The unit is fitted with a condensate discharge point that needs to be connected to a sanitary sewer.

The unit involves replaceable G3 class air filters (for fine dust).

As a result of the unit's high efficiency, during periods of extreme frost the heat exchanger might suffer from freezing; for this reason the unit is equipped with an automatic defrosting function. The heat exchanger freezing can be prevented by installing an air duct heater on the intake air duct – see the Air Duct Heaters chapter.

A compact size and a very low noise level are the big advantages of this unit.

**Code: 10335**

### PERFORMANCE MODES

3 performance modes (speeds) are preset in the unit in relation to the space to be ventilated. Preset values can be changed freely. Switching between low and medium speed modes is automatic following the preset time program. High speed mode (boost) can be switched on either periodically, or by schedule, or by pressing a key. The boost mode start can be also automatic, e.g. by turning on the light in toilet.



### TECHNICAL DATA

#### PERFORMANCE DATA

Max. air flow rate *	490 m <sup>3</sup> /h
Heat recovery efficiency	max. 92%
Energy Efficiency Class	A+
Low air flow	20 % (preset)
Medium air flow	30 % (preset)
High air flow	50 % (preset)
Purge	100%

\*flow rates for specific installations shall be modified by performance diagrams

#### ACOUSTIC DATA

Sound level (at 3m distance)	24 dB(A) for medium air flow
	34 dB(A) for high air flow

### DIMENSIONS

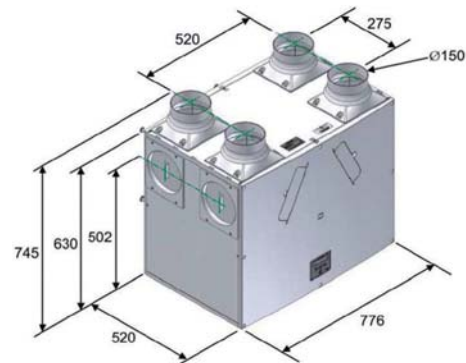

### ACCESSORIES

The inbuilt control panel permits connection of external control elements, e.g. a humidity sensor or a carbon dioxide sensor. A remote control panel can be connected as well which is suitable in installations where the unit is located at a not easily accessible place.

#### Air flow settings with respect to the total floor area of ventilated rooms.

Max. ventilated room		Low air flow		Medium air flow		High air flow (boost)	
living area	space volume	setting	[m <sup>3</sup> /h]	setting	[m <sup>3</sup> /h]	setting	[m <sup>3</sup> /h]
150 m <sup>2</sup>	375 m <sup>3</sup>	10%	40	40%	150	60%	250
170 m <sup>2</sup>	425 m <sup>3</sup>	15%	60	45%	170	70%	280
200 m <sup>2</sup>	500 m <sup>3</sup>	25%	90	50%	200	80%	330
230 m <sup>2</sup>	575 m <sup>3</sup>	30%	120	60%	250	100%	380

# CENTRAL HRV UNITS



## Sentinel Kinetic Horizontal 200ZPH

A central heat recovery ventilation unit, designed for continuous ventilation of family homes and flats of living area up to 120 sqm.

Kinetic Horizontal 200 ZPH HRV Units are equipped with an integrated digital controller, automatic bypass, humidity sensor and a condensate discharge point. For the most comfortable ventilation, also carbon dioxide sensors, humidistats, PIR sensor and similar can be added.

Horizontal 200 ZPH HRV Units, just 200 mm high, offer many variants for placing inside the rooms to be ventilated. They are especially suitable for installation into a ceiling void, or freely under the ceiling and into roof framing. In order to minimize heat loss and permit installation into unheated rooms, the unit is fully thermally insulated.

Two G3 filters are integrated in Kinetic Advance units for the sake of a healthy climate inside the building.

Due to the high efficiency of the unit, the heat exchanger could suffer from ice formation under extreme frost. For this reason the unit is equipped with an automatic defrost function. A frozen heat exchanger can be also prevented by installing an air duct heater in the intake air duct – see the chapter Air duct heaters.

A cooler outdoor air can be used to help cool the building via the integrated summer bypass.

**Code: 16709**

### PERFORMANCE MODES

A different ventilation intensity can be programmed for different day times. The unit comes with a digital controller that can be placed inside the dwelling and used for a quick change in ventilation modes depending on the individual needs of the user. The integrated humidity sensor increases speed in proportion in order to ensure optimum relative humidity levels. The integrated timer function in the unit will also ensure sufficient room ventilation with the possibility of relative humidity boost.

### TECHNICAL DATA

#### PERFORMANCE DATA

Max. air flow rate *	168 m <sup>3</sup> /h
Heat recovery efficiency	max. 86 %
Energy Efficiency Class	A
Low air flow	20 % (preset)
Medium air flow	30 % (preset)
High air flow	50 % (preset)
Purge	100 %

\*flow rates for specific installations shall be modified by performance diagrams

#### ACOUSTIC DATA

Sound level (at 3m distance)	20,8 dB(A) for medium air flow 27,7 dB(A) for high air flow
---------------------------------	--

### DIMENSIONS

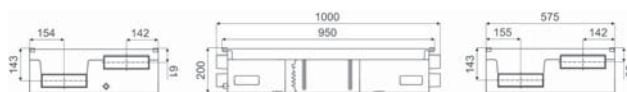

### ACCESSORIES

Remote control with 15m cable, for Sentinel Kinetic

**Code: 10757**



# CENTRAL HRV UNITS

## HR 100 R, HR 100 RS

Central HRV units intended for ventilation of small flats or single rooms, featuring 2 speed modes - low and high. They need an external switch for control, mostly a plain rocker switch on a wall or a humidistat.

Both the HRV unit and air ducts are usually installed into a ceiling void or unused attic.

HR 100 R is suitable for attic-room installations. The service panel is located on its upper side.

**Code: 7483**

HR 100 RS is suitable for ceiling void installations or for ceiling mount. The service panel is located on its bottom.

**Code: 10308**



### TECHNICAL DATA

#### PERFORMANCE DATA

Air flow	66 m <sup>3</sup> /h (max. air flow) 48 m <sup>3</sup> /h (current air flow)
Heat recovery efficiency	max. 70%

#### ACOUSTIC DATA

Sound level (at 3m distance)	20 dB(A) for current air flow 30 dB(A) for max. air flow
---------------------------------	---

### DIMENSIONS

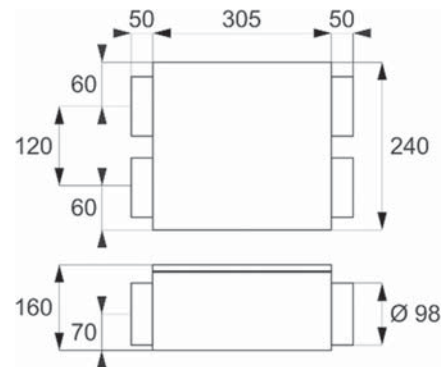

### ACCESSORIES

G3 class air filters (fine dust) and insulation kits for heat loss reduction are available as accessories.



## SINGLE-ROOM HRV UNITS

### HR 100 W, HR 30 W

Single-room HRV units intended for ventilation of single rooms (living rooms, kitchens, bathrooms, toilets etc.). They feature 2 speed modes – low and high, and an external switch is needed for control, mostly a plain rocker switch on a wall or a humidistat.

This unit is designed to be installed in a wall, its suitable thickness is between 220 and 280 mm (up to 500mm with an extension, see Accessories).

**Code:**

**HR 100 W: 6955**

**HR 30 W: 6954**



#### TECHNICAL DATA

PERFORMANCE DATA	HR 100 W	HR 30 W
Low air flow - intake	38 m <sup>3</sup> /h	30 m <sup>3</sup> /h
Low air flow - exhaust	43 m <sup>3</sup> /h	35 m <sup>3</sup> /h
High air flow - intake	69 m <sup>3</sup> /h	40 m <sup>3</sup> /h
High air flow - exhaust	77 m <sup>3</sup> /h	50 m <sup>3</sup> /h
Heat recovery efficiency	max. 70 %	max. 70 %

#### ACOUSTIC DATA

Sound level (at 3 m distance)	20 dB(A) for low air flow	
	35 dB(A) for high air flow	28 dB(A) for high air flow



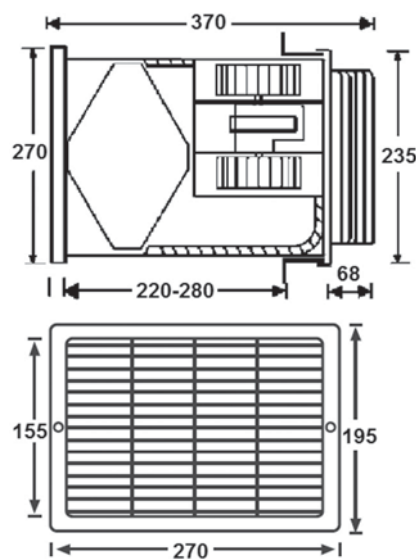













#### DIMENSIONS



#### ACCESSORIES

EXT100 Extension is available that permits installation into thicker walls, 280-500 mm.

## ACCESSORIES TO HEAT RECOVERY VENTILATION UNITS

ACCESSORIES	CODE	
	Humidity sensor for Sentinel Kinetic	<b>10177</b>
	CO <sub>2</sub> sensor for Sentinel Kinetic	<b>11852</b>
	Remote control, 15m cable, for Sentinel Kinetic	<b>10757</b>
	Connection Kit - Sentinel Kinetic B + IR 12 Controller	<b>17459</b>
	Connection Module - Sentinel Kinetic B to IR 12 via CIB	<b>17786</b>
	Connection Module - Sentinel Kinetic Advance to IR 12 via CIB	<b>17787</b>
	Wireless boost switch for Sentinel Kinetic	<b>10756</b>
	WiFi Module for Sentinel Kinetic Advance S	<b>16607</b>
	WiFi Module for Sentinel Kinetic Advance S	<b>16608</b>
	Docking station for Advance unit control module, incl. 15 m cable	<b>16609</b>
	Voltage-free Extension Module for Sentinel Kinetic Advance, 4 inputs	<b>16610</b>
	Extension Module for Sentinel Kinetic Advance, 2 inputs	<b>16611</b>
	HR-S Humidistat - 35-95% RH, mechanical type	<b>14334</b>
	Circuit breaker for Sentinel	<b>9532</b>
	Insulation for HR 100 R HRV unit	<b>11767</b>
	Insulation for HR 100 RS HRV unit	<b>11768</b>

# ROUND FLEXIBLE ALUMINIUM DUCTS

Ducting can be bent easily so no elbows are needed. These hoses are delivered in one- or two-layer versions, with 25 cm thick insulation.

**The duct size depends on the air volume to be transported (unit size):**

HR 100 R.....	DN 100 mm
Sentinel Kinetic B.....	DN 125 mm
Sentinel Kinetic B Plus.....	DN 150 mm - backbone duct, for branches 125mm is sufficient
Sentinel Kinetic Horizontal.....	200x60 mm
Sentinel Kinetic Advance.....	DN 125 mm

For HR 100R and in confined spaces also for Sentinel models, the ducts supplying air to small rooms under 15 sqm can be reduced even to 100mm in diameter.

Metal adapters are used to make branches or transitions. A flexible duct shall be shifted onto the adapter and fixed with a hose band or a duct tape.

## HOSE BAND, CLAMP

Hose band is available in 30m coils. Any desired portion of the hose band can be cut off and fitted with a clamp.

**Hose band code: 9209. Clamp code: 9210 - 1 piece, 17061 - 50 pcs bulk pack.**



## DUCT TAPE

Aluminium foil tape (no mesh), 50 mm wide and 0.3 mm thick, 50 m.

**Code: 11515**





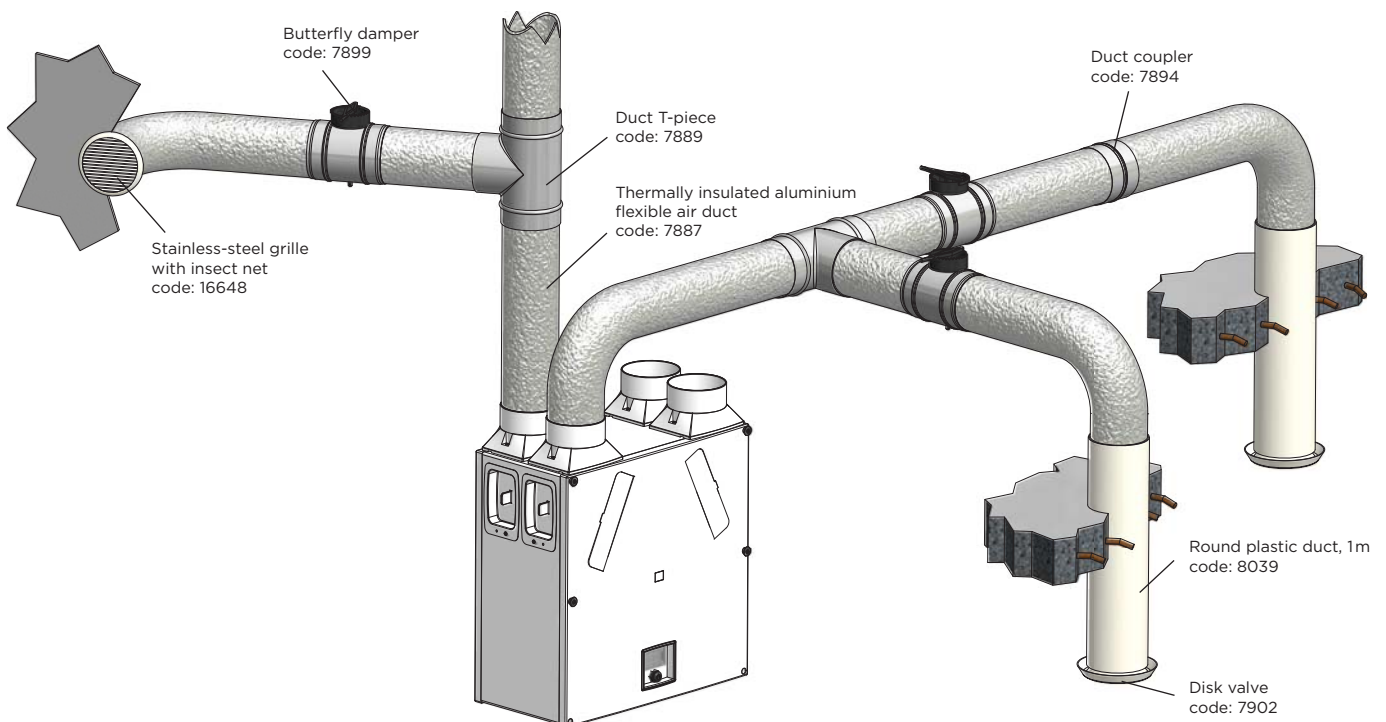



## Installation example with round aluminium air ducts



## Through the wall ducts

Round plastic duct shall be fitted into a wall and fixed with mortar. Its outer diameter shall correspond to the flexible duct diameter. About 3 cm of the rigid duct shall be left protruding from the wall, enabling the flexible duct be shifted on it.



ROUND HOSES		CODE
	Single layer aluminium flexible air duct, 100 mm x 5 m	<b>7743</b>
	Single layer aluminium flexible air duct, 125 mm x 5 m	<b>7589</b>
	Single layer aluminium flexible air duct, 150 mm x 5 m	<b>7886</b>
	Insulated aluminium flexible air duct, 102 mm x 10 m	<b>8000</b>
	Insulated aluminium flexible air duct, 127 mm x 10 m	<b>7887</b>
	Insulated aluminium flexible air duct, 152 mm x 10 m	<b>7888</b>
	Insulated aluminium flexible air duct, 203 mm x 10 m	<b>8037</b>
FITTINGS		CODE
	Duct coupler, 100 mm	<b>8854</b>
	Duct coupler, 125 mm	<b>7894</b>
	Duct coupler, 150 mm	<b>7895</b>
	Duct reducer, 125/100	<b>7896</b>
	Duct reducer, 150/125	<b>7897</b>
	Duct reducer, 150/100	<b>16653</b>
	Duct reducer, 200/150	<b>7904</b>
	Duct T-connector, 100/100	<b>7769</b>
	Duct T-connector, 125/100	<b>7721</b>
	Duct T-connector, 125/125	<b>7889</b>
	Duct T-connector, 150/100	<b>7890</b>
	Duct T-connector, 150/125	<b>7908</b>
	Duct T-connector, 150/150	<b>7891</b>
COMPONENTS		CODE
	Butterfly damper, 100 mm	<b>7898</b>
	Butterfly damper, 125 mm	<b>7899</b>
	Butterfly damper, 150 mm	<b>7900</b>
	Airtight butterfly damper, 100 mm	<b>7771</b>
	Airtight butterfly damper, 125 mm	<b>10872</b>
	Airtight butterfly damper, 150 mm	<b>11565</b>

## SANIFLEX FLEXIBLE ROUND ANTIBACTERIAL DUCTS

SANIFLEX is flexible round antibacterial thermally insulated ducting. The inner air duct is a foil made of self-extinguishing poly-olefin resins with silver ions that prevent growth of a wide range of microorganisms. The next layer is formed by a 25 mm thick thermal insulation of mineral wool with a plastic outside jacket that offers excellent vapour barrier, preventing moisture condensation. SANIFLEX is suitable also for more demanding applications in air distribution, air conditioning and heating.

AIR DUCTS	CODE
 Thermally insulated antibacterial air duct 127 mm x 10 m	<b>16068</b>

## RIGID ROUND EPP DUCTS

The EPP ducting system is made of extruded polypropylene. It has a number of advantages: it is light, rigid, easy and quick to work with. The system achieves Class C leak tightness. It does not require additional insulation and eliminates thermal bridges.

It is made in diameters 125 mm and 150 mm.

Standard wall thickness is 15 mm. The 90° elbow can be cut to create two 45° elbows (one coupler needs to be added).

### RIGID ROUND EPP DUCTS

### CODE



Round EPP duct, 0.5m

125 mm

**18064**

150 mm

**18065**



90° EPP elbow

125 mm

**18068**

150 mm

**18069**



45° EPP elbow

125 mm

**18070**

150 mm

**18071**



EPP coupler

125 mm

**18072**

150 mm

**18073**

## RIGID ROUND PE DUCTS

### RIGID ROUND PE DUCTS

### CODE



Round plastic duct, 1m

100 mm

**8852**

125 mm

**8039**

150 mm

**16731**



90° Elbow

100 mm

**18164**

125 mm

**18165**

150 mm

**18166**



45° Elbow

100 mm

**18167**

125 mm

**18168**



Tee

100 mm

**18161**

125 mm

**18162**

150 mm

**18163**



Duct coupler

100 mm

**18169**

125 mm

**18170**

150 mm

**18171**



Duct reducer

125/100 mm

**18172**

150/125 mm

**18173**



# HIGHLY RESISTANT FLEXIBLE PE AIR DUCTS

Air ducting made of special polyethylene, its inner wall with smooth surface offers low pressure drop for air transport and easy cleaning. Its small diameter (75 mm) permits easy installation into suspended ceiling. High mechanical resistance enables also installation into floors, to concrete screed. The duct material contains ions of silver that ensure antistatic, antibacterial and antifungal protection.

## Advantages:

- minimum pressure drop
- easy cleaning
- simple handling and installation
- noise suppression
- hygienic protection
- long service life

## Installation example with PE round ducting

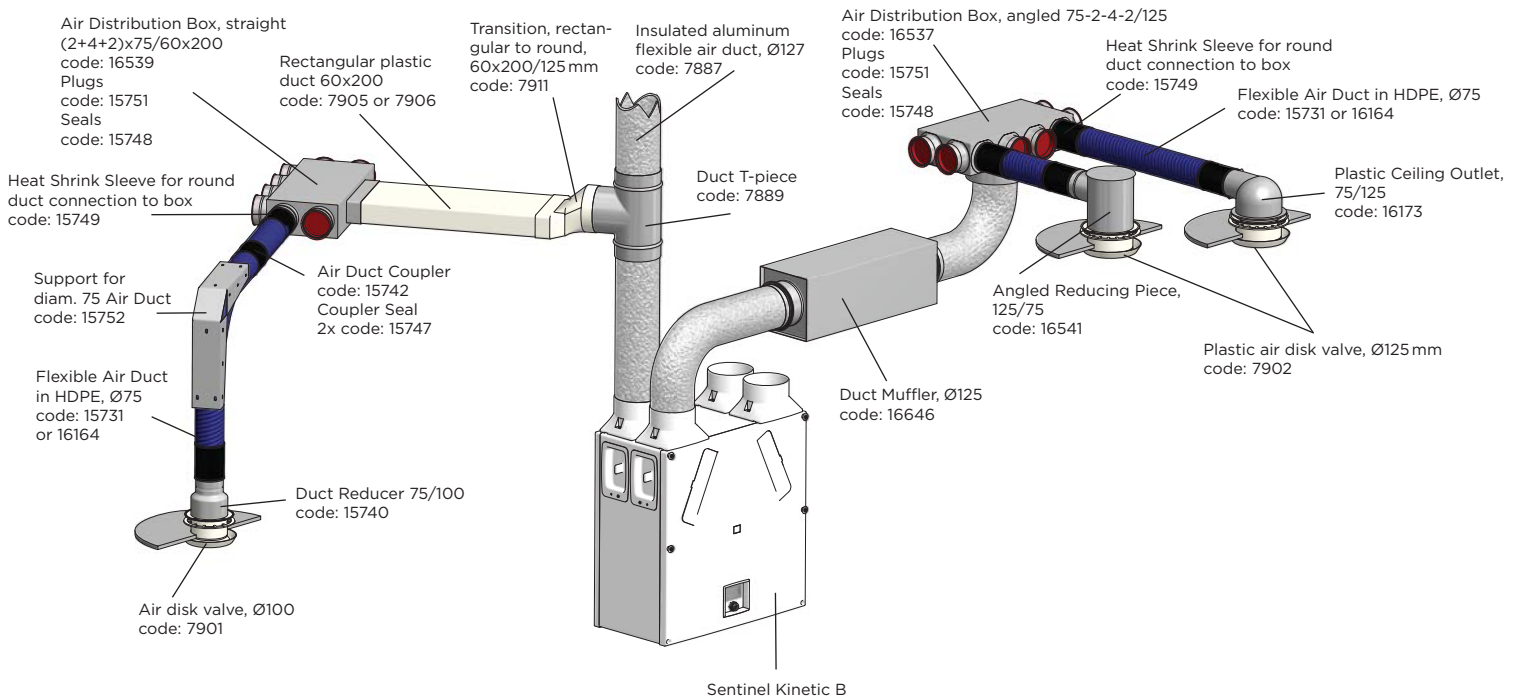

## Flexible pipes

Delivered in 10 or 50m bulk pack, ends plugged.



## Distribution boxes

Designed as connection parts for separate branches of FLX-HDPE-A ducts, connection for flexible aluminium air ducts.



**ROUND AIR DUCTS****CODE**

- ø 75 Air Duct, antibacterial - 50 m (FLX-HDPE-A-75)
- ø 75 Air Duct, antibacterial - 10 m (FLX-HDPE-A-75-10)

**15731**  
**16164**

**PLASTIC AIR DISTRIBUTION BOXES****CODE**

- Plastic Air Distribution Box 2x75/125
- Plastic Air Distribution Box, angled 2x75/125
- Plastic Air Distribution Box, angled (2+2+2+2)x75/125
- Plastic Air Distribution Box, angled (4+2+4+2)x75/125

**18773**  
**18770**  
**18772**  
**18771**

**METAL AIR DISTRIBUTION BOXES****CODE**

- Air Distribution Box, angled, 3x75/125 (FLX-PRO-75-3)
- Air Distribution Box, angled, (1+3+1)x75/125 (FLX-BRR-75-1-3-1/125)
- Air Distribution Box, angled, (2+4+2)x75/125 (FLX-PRO-75-2-4-2)
- Air Distribution Box, angled, (2+4+2)x75/150 (FLX-BRR-75-2-4-2/150)
- Air Distribution Box, angled, (1+3+1)x75/60x200 (FLX-BRP-75-1-3-1/60x200)
- Air Distribution Box, angled, (2+4+2)x75/60x200 (FLX-BRP-75-2-4-2/60x200)

**15733**  
**16536**  
**16537**  
**16538**  
**16540**  
**16539**

**ACCESSORIES****CODE**

- Extension, 125 mm x 0.5 m
- Extension, 150 mm x 0.5 m
- Butterfly damper (FXL-DAS-75)
- 90° Bend (FLX-BP-75)
- 100/75 Adapter (FLX-RPC-100-75)
- 125/75 Adapter (FLX-RPC-125-75)
- Angled Reducing Piece, 125/75 (FLX-RR-75/125)
- Support for flexible air duct (FLX-FAX-75)
- Flexible Duct Coupler (FLX-MSF-75)
- Heat shrink sleeve (FLX-UST-75)
- Gasket between flexible duct and box (FLX-USC-75)
- Gasket between flexible duct and coupler (FLX-USZ-75)
- Air Distribution Box Plug (FLX-CF-PVC-75)
- Flexible Duct Plug (FLX-CS-PVC-75)
- DUCT Universal silver adhesive tape - 50 mm x 50 m x 0.15mm, up to 60 °C
- TALE Sealing tape (reinforced with glass fibre mesh) - 50 mm x 50 m x 0.3mm, up to 120 °C

**16542**  
**16706**  
**16730**  
**15739**  
**15740**  
**15741**  
**16541**  
**15752**  
**15742**  
**15749**  
**15748**  
**15747**  
**15751**  
**15750**  
**16654**  
**16655**

## RECTANGULAR PLASTIC DUCTS





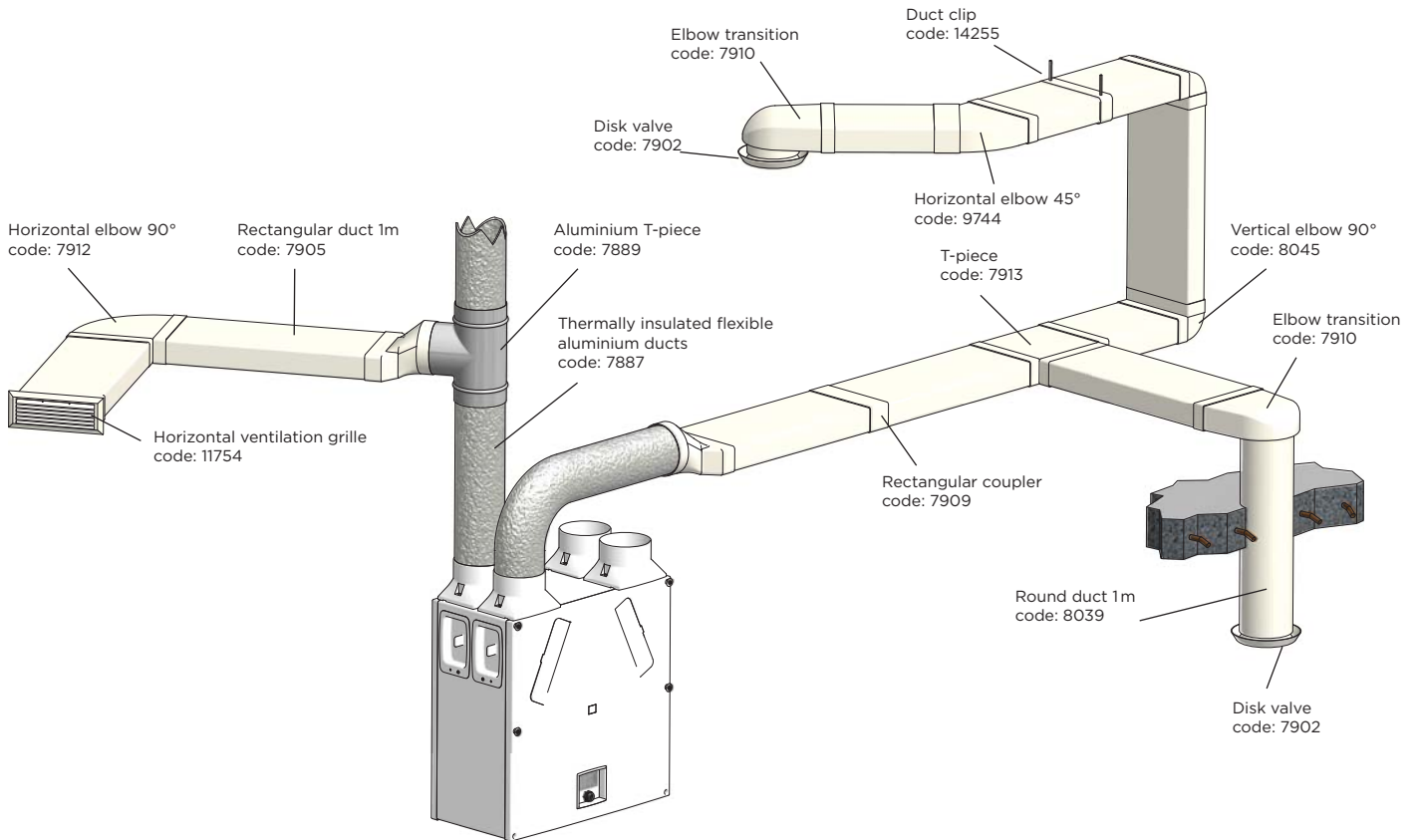

Plastic ducting of 60x200mm cross section. It is so flat that it can be installed even into constrained ceiling voids or floors. The plastic ducts are rigid so transitions are needed to change the direction or divide the air flow - bends or T-pieces. When installed into an unheated space (attic), additional insulation is needed.

Rectangular plastic ducting connects through so called sockets. Straight sections are slid into the sockets of shaped transitions, and two transitions cannot be connected directly, only through a section of a straight duct.

### Installation example with rectangular plastic air ducts







**RECTANGULAR PLASTIC DUCTS**
**CODE**

	Rectangular plastic ducts, 60x200 mm, 1m	<b>7905</b>
	Rectangular plastic ducts, 60x200 mm, 1.5 m	<b>7906</b>
	Rectangular coupler, 60x200 mm	<b>7909</b>
	Elbow transition, rectangular to round, 60x200/125 mm	<b>7910</b>
	Elbow transition, rectangular to round, 60x200/100 mm	<b>8243</b>
	Rectangular to round transition, 60x200/125 mm	<b>7911</b>
	Rectangular to round transition, 60x200/100 mm	<b>18160</b>
	Horizontal elbow 90°, 60x200 mm	<b>7912</b>
	Horizontal elbow 45°, with divisible segments, 60x200 mm	<b>9744</b>
	Horizontal elbow 45°, without divisible segments, 60x200 mm	<b>18557</b>
	Vertical elbow 90°, 60x200 mm	<b>8045</b>
	Vertical elbow 45°, 60x200 mm	<b>18157</b>
	T-piece T, 60x200 mm	<b>7913</b>
	Drop down section, 60x200 mm	<b>18158</b>
	Horizontal ventilation grille, 60x200 mm, enlarged frame	<b>11754</b>
	Horizontal ventilation grille, 60x200 mm, with frame into coupler	<b>18578</b>
	Vertical ventilation grille, 60x200 mm	<b>18159</b>
	Round plastic duct, 100 mm x 1m	<b>8852</b>
	Round plastic duct, 125 mm x 1m	<b>8039</b>
	Round plastic duct, 150 mm x 1m	<b>16731</b>
	Rectangular duct clip, 204x60 mm	<b>14255</b>

## Air duct heaters

An air duct heater installs directly into a round duct upstream of the heat recovery unit. It is intended primarily for preventing the unit from entering defrost mode, i.e. from creating a slight negative pressure inside the building. A heater of circa 400W output is sufficient to pre-heat the incoming air. The heater is thermostat-controlled, switching on for low outdoor temperature periods only.

AIR DUCT HEATERS		CODE
	Electric air duct heater, 0.4 kW DN 125, incl. an adjustable and safety thermostats, 3m cable	<b>14059</b>
	Electric air duct heater, 0.6 kW DN 150, incl. an adjustable and safety thermostats, 3m cable	<b>14769</b>
	HDW 150 Air duct heater for ducts of 150 mm diam., max. air flow rate 400 m <sup>3</sup> /h, 2.8 kW output (at 300 m <sup>3</sup> /h air flow rate, 60°C inlet water temperature and 0°C incoming air temperature).	<b>18642</b>
	MKV 150 Air duct heater/cooler, connection diam. 150 mm, for max. air flow rate of 300 m <sup>3</sup> /h, with condensate drain and drop eliminator, 1.6 kW cooling output (at 300 m <sup>3</sup> /h air flow rate, 7°C inlet water temperature, 28°C incoming air temperature), 2 kW heating output (at 300 m <sup>3</sup> /h air flow rate, 50°C inlet water temperature, 15°C incoming air temperature)	<b>18139</b>
	Insulation Kit for MKV 150 Air Heater/Cooler	<b>18269</b>

## Duct noise muffler

Insulated flexible ducts have very good soundproofing properties. Should there be less than 3m from the unit to the closest outlet, it is advisable to install a duct muffler.

**Code: 16646**





## Air disk valves





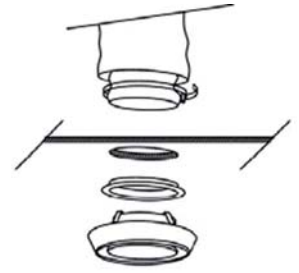













It is advisable to use plastic disk valves for easy installation and proper air distribution in a room. They are user-adjustable from inside the ventilated room and can be mounted into a ceiling or a suspended ceiling, fitted on a plastic transition piece or on a flexible aluminium duct. When connected to a 75mm flexible air duct, a straight steel reducer or a ceiling plastic air disk valve shall be used. The valve diameter depends on the diameter of the ducting and on the size of the ventilated room.

Round grilles may be fitted into walls.



### AIR DISK VALVES

### CODE

	RV Designer Air Disc Valve, 125mm diam., small		<b>18766</b>
	RV Designer air disc valve, 125mm diam., big - lacquered aluminium		<b>18767</b>
	RV Designer air disc valve, 125mm diam., square - lacquered aluminium		<b>18768</b>
	Shield for RV designer air disc valve		<b>18769</b>
	Supply and exhaust plastic air disk valve	100 mm	<b>7901</b>
	Supply and exhaust plastic air disk valve	125 mm	<b>7902</b>
	G2 Filter for air disk valves 7901, 7902	100 mm	<b>18619</b>
	G2 Filter for air disk valves 7901, 7902	125 mm	<b>18620</b>
	Vyústka stropní plastová 75/125		<b>16173</b>
	Round plastic grille, insect net, 80-125 mm		<b>9002</b>
	Round grille in CrNi stainless steel, insect mesh	100 mm	<b>16647</b>
	Round grille in CrNi stainless steel, insect mesh	125 mm	<b>16648</b>
	Round grille in CrNi stainless steel, insect mesh	150 mm	<b>16649</b>
	Round grille in CrNi stainless steel, bull nose, insect mesh	100 mm	<b>16650</b>
	Round grille in CrNi stainless steel, bull nose, insect mesh	125 mm	<b>16651</b>
	Round grille in CrNi stainless steel, bull nose, insect mesh	150 mm	<b>16652</b>
	Vertical terminal 125 mm		<b>175</b>
	Pitched-roof flashing, malleable Al sheet		<b>8014</b>

# Adjustable RV air disk valves



For air supply/extract, suitable for air flow rate up to 21 l/s



Easy adjusting: 26 lockable positions



Low noise level and small pressure drop

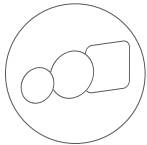

Three designs to fit in various interiors

Outer dimensions are the same disregarded of the selected flow rate setting

For all air ducts with connection diam. 116 or 155 mm



Easy cleaning: no need to disassemble the valve base

Low turbulent air flow: prevents dirt accumulation around the valve

## ACOUSTIC DATA





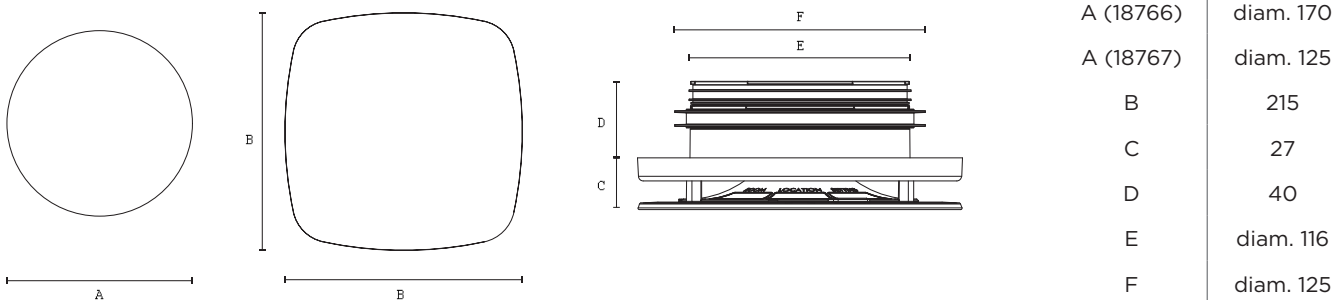



	Air supply		Air extraction	
	13 l/s	21 l/s	13 l/s	21 l/s
Valve open				
50 %	< 22 dB(A)	25 dB(A)	< 22 dB(A)	24 dB(A)
100 %	23 dB(A)	29 dB(A)	< 22 dB(A)	25 dB(A)

## DIMENSIONS



Material - lacquered aluminium.

## Filters for HRV units

FILTERS FOR HRV UNITS		CODE
	Filter fabric for Sentinel Kinetic B - set of 2 G3 filters	<b>13323</b>
	Filter fabric for Sentinel Kinetic B - set of 2 G5 pollen filters	<b>13324</b>
	Filter fabric for Sentinel Kinetic B Plus - set of 2 G3 filters	<b>13325</b>
	Filter fabric for Sentinel Kinetic B Plus - set of 2 G5 pollen filters	<b>13326</b>
	Filter for Sentinel Kinetic B - set of 2 G3 filters	<b>17026</b>
	Filter for Sentinel Kinetic B - set of 2 G5 pollen filters	<b>17572</b>
	Filter for Sentinel Kinetic B Plus - set of 2 G3 filters	<b>17028</b>
	Filter for Sentinel Kinetic B Plus - set of 2 G5 pollen filters	<b>17573</b>
	Filter fabric for HR 30 W, HR 100 W	<b>9001</b>
	Filter fabric for HR 100 R	<b>8136</b>
	Filter for Sentinel Kinetic Advance - set of 2 G3 filters	<b>16891</b>
	Filter for Sentinel Kinetic Advance - set of 2 G5 pollen filters	<b>16892</b>
	Filter for Sentinel Kinetic Advance - 1 pocket F5 pollen filter	<b>17024</b>
	Filter for Sentinel Kinetic Advance - 1 pocket F7 pollen filter	<b>17025</b>
	Filter for Sentinel Kinetic Horizontal - set of 2 G3 filters	<b>17030</b>

## Duct cleaning spray

Air ducts cleaning is often difficult, for this reason we recommend using a chemical spray. The frequency of chemical treatment depends on the quality of air supplied from outside / extracted from inside the building. The minimum cleaning interval is once a year.

**Code: 10686**









