

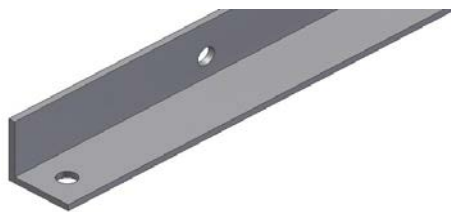





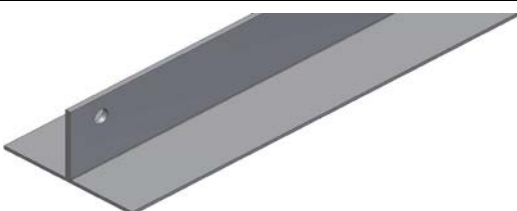
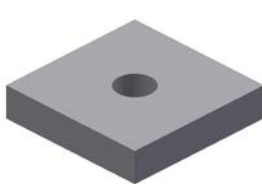

## Držiak pre slnečný kolektor / Support bracket for solar collector

Rovná strecha - trojuholníková podpera 25° kód 10975 / Flat roof - triangle bracket 25° code 10975

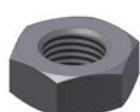
Obrázok Fig.	Označenie Name	Rozmer Dimensions	Množstvo Qty	Kód diela Code
	Profil "L" 30x30x3 hliník / L-beam 30x30x3 in aluminum	Dĺžka 1860 mm / Length 1860 mm	1 ks / 1 piece	<b>9470</b>
	Profil základný "H"-hliník / Basic H-beam in aluminum	Dĺžka 820 mm / Length 820 mm	1 ks / 1 piece	<b>11095</b>
	Profil základný "T" č.12197 - hliník / T-beam no.12197 in aluminium	Dĺžka 1700 mm / Length 1700 mm	1 ks / 1 piece	<b>9469</b>
	Podložka držiaka Al / Square washer for collector support, aluminum	32x32 hr. 8 mm / 32x32, 8 mm thick	2 ks / 2 pcs	<b>9405</b>
	Skrutka M8x45 nerez (imbus) DIN 912/A2 / Socket screw M8x45, stainless steel DIN 912/A2	M8x45	2 ks / 2 pcs	<b>9564</b>
	Skrutka M8x16 nerez (imbus) DIN 912/A2 / Socket screw M8x16, stainless steel DIN 912/A2	M8x16	1 ks / 1 piece	<b>6926</b>
	Matica M8 nerez DIN 934/A2 / M8 Hex nut, stainless steel DIN 934/A2	M8	5 ks / 5 pcs	<b>8381</b>
	Podložka 8,4 nerez DIN 125/A2 / 8.4 Flat washer, stainless steel DIN 125/A2	pr.8,4 mm / diam. 8.4 mm	3 ks / 3 pcs	<b>7256</b>
	Podložka vejárová vonkajšie ozubenie 8,4 DIN 6798 A/A2 nerez / Serrated tooth washer, 8.4, DIN6798 A/A2, stainless steel	pr.8,4 mm / diam. 8.4 mm	5 ks / 5 pcs	<b>8382</b>
	Skrutka M8x30 veľká hlava - pre základný profil / M8x30 bolt with big T head, for H-beam	M8x30	2 ks / 2 pcs	<b>8369</b>
	Krytka H profilu / H-rail end plug		1 ks / 1 piece	<b>11773</b>

**Zostavenie držiakov pre slnečné kolektory,  
pre rovné strechy - zvýšenie uhla o 25°.**

*Assembly of triangle brackets for solar collectors, for  
flat roofs-angle increase by 25°.*

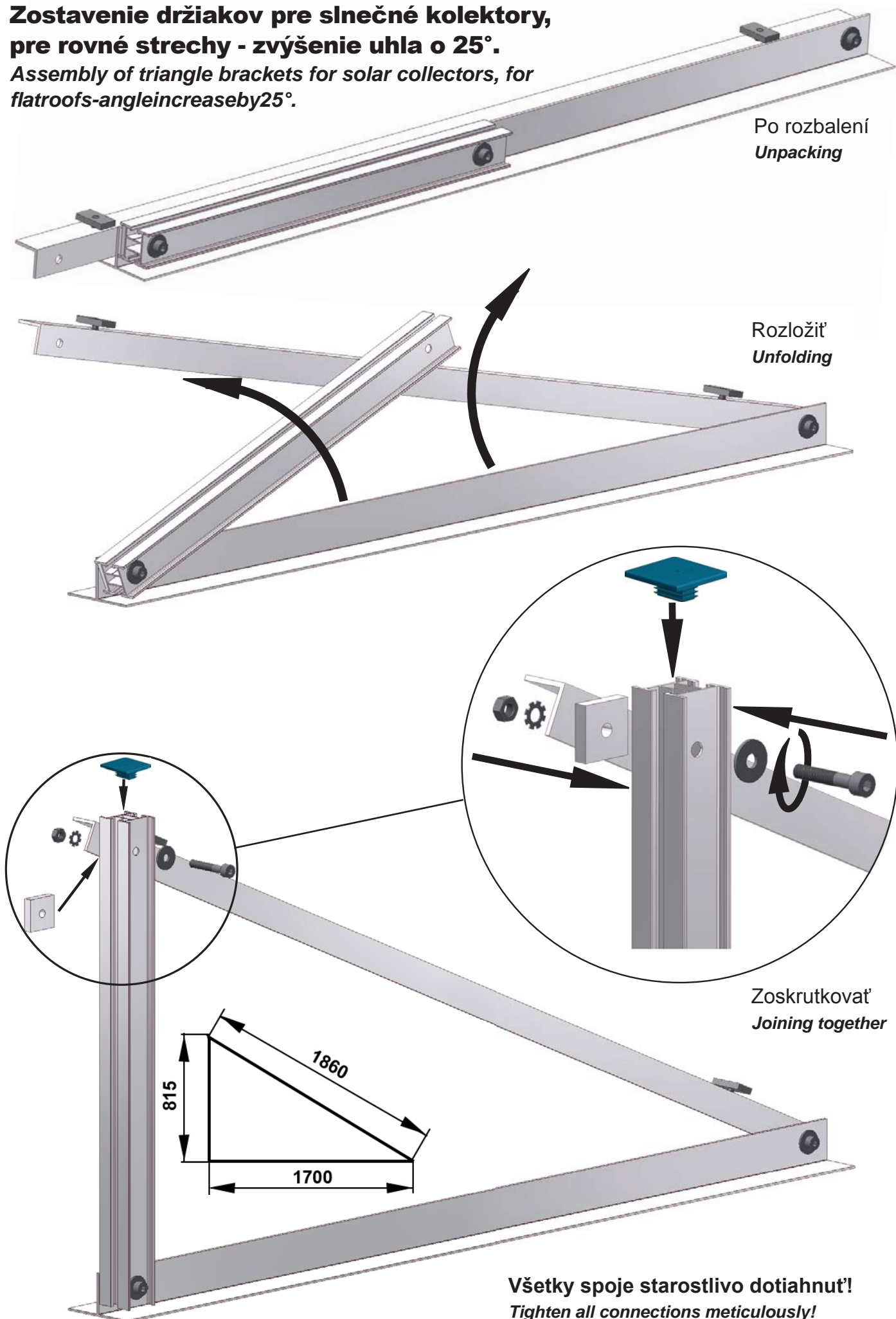

Po rozbalení  
*Unpacking*

Rozložiť  
*Unfolding*

Zoskrutkovať  
*Joining together*

**Všetky spoje starostlivo dotiahnuť!**  
*Tighten all connections meticulously!*