

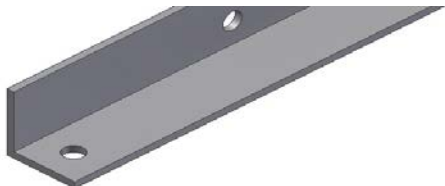





**Držiak pre úpravu sklona kolektorov (vhodné na háky do šikmých striech)**  
*Support bracket for solar collector inclination adjustment (suitable for sloping roof anchors)*

**Uhol 25° - kód 8805 / 25 degree angle - code 8805**

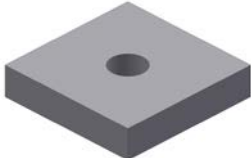
Obrázok Fig.	Označenie Name	Rozmer Dimensions	Množstvo Qty	Kód diela Code
	Profil základný "H"- hliník / Basic H-beam in aluminum	Dĺžka 1650 mm / Length 1650 mm	1 ks / 1 piece	<b>11095</b>
	Profil "L" 30×30×3 - hliník / L-beam 30×30×3 in aluminum	Dĺžka 1850 mm / Length 1850 mm	1 ks / 1 piece	<b>9470</b>
	Profil základný "H"- hliník / Basic H-beam in aluminum	Dĺžka 800 mm / Length 800 mm	1 ks / 1 piece	<b>11095</b>
	Matica pre držiak kolektora / Special nut for collector support	<b>M8</b>	1 ks / 1 piece	<b>11155</b>
	Podložka držiaka Al / Square washer for collector support, aluminum	<b>32×32 hr. 8 mm / 32×32, 8 mm thick</b>	2 ks / 2 pcs	<b>9405</b>
	Skrutka M8×50 nerez (imbus) DIN 912/A2 / Socket screw M8×50, stainless steel DIN 912/A2	<b>M8×50</b>	2 ks / 2 pcs	<b>9982</b>
	Skrutka M8×80 nerez (imbus) DIN 912/A2 / Socket screw M8×80, stainless steel DIN 912/A2	<b>M8×80</b>	1 ks / 1 piece	<b>11156</b>
	Podložka 8,4 nerez DIN 125/A2 / 8.4 Flat washer, stainless steel DIN 125/A2	<b>pr.8,4 mm / diam. 8.4 mm</b>	7 ks / 7 pcs	<b>7256</b>
	Matica M8 nerez DIN 934/A2 / M8 Hex nut, stainless steel DIN 934/A2	<b>M8</b>	4 ks / 4 pcs	<b>8381</b>
	Skrutka M8×30 veľká hlava - pre základný profil / M8x30 bolt with big T head, for H-beam	<b>M8×30</b>	2 ks / 2 pcs	<b>8369</b>
	Podložka vejárová - vonkajšie ozubenie 8,4 DIN 6798 A/A2 nerez /Serrated tooth washer, 8.4, DIN6798 A/A2, stainless steel	<b>pr.8,4 mm / diam. 8.4 mm</b>	5 ks / 5 pcs	<b>8382</b>
	Krytka H profilu / H-rail end plug		3 ks / 3 pcs	<b>11773</b>

# Zostavenie držiakov pre slnečné kolektory, pre šikmé strechy - zvýšenie uhla o 25°.

Assembly of triangle brackets for solar collectors, for sloping roofs - angle increase by 25°.

Po rozbalení  
Unpacking

Rozložiť  
Unfolding

Zoskrutkovať  
Joining together

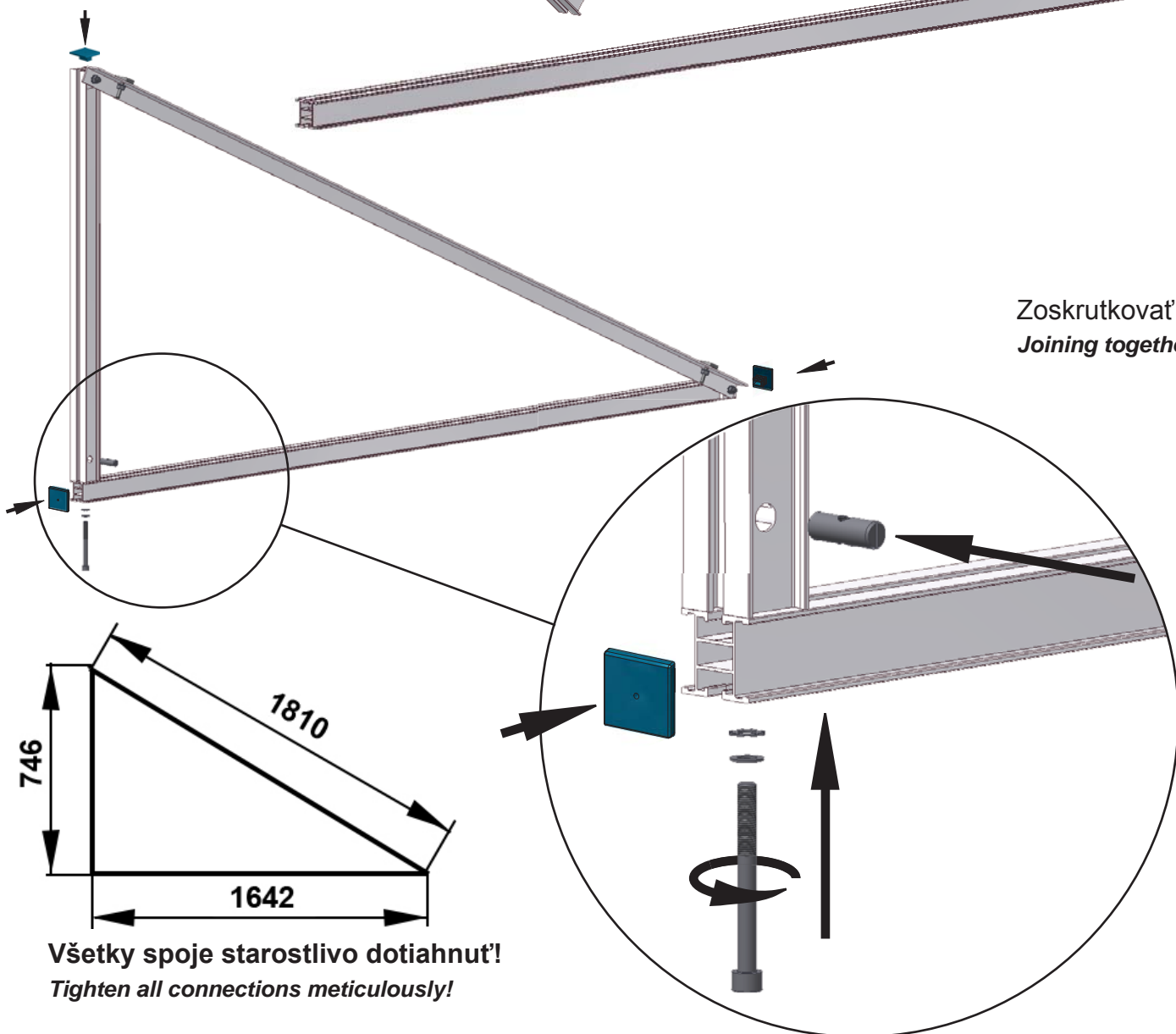

Všetky spoje starostlivo dotiahnuť!  
Tighten all connections meticulously!