

Regulus

SOLAR PUMP STATIONS



SOLAR PUMP STATIONS

CSE SOL Solar Pump Station is designed to be installed in the return line of a solar thermal system. It ensures solar fluid circulation, flow measurement and control, solar thermal system protection and monitoring. It is intended for installation on a wall or on a thermal store / storage tank that permit this. It contains all components necessary for an efficient and safe operation of a solar thermal system. The thermo-insulating cover is designed in detail, ensuring operation with minimum heat loss. The pump station is completely internally wired, in most applications its installation can be performed without an electrician, which significantly shortens and reduces the cost of installation.



ADVANTAGES

No draining needed
Easily removable check valve, no need to drain the solar thermal system.

No crossing pipes
The safety valve outlet below the pump station does not cross the pipe to an expansion vessel.

Complete insulation
Thermal insulation of the safety valve assembly is included - low heat loss guaranteed.

Automatic control
The controller controls the pump speed and displays the flow rate. No need to set a flow rate. In CSE SOL W models the flow rate is shown on the controller display, in CSE SOL G models the flow rate can be read on a mechanical flow meter located under the pump.

Installation without electrician
The pump station connects via a 3m cable to a wall socket, a heating element or a gas boiler via a dedicated terminal.

CSE SOL W models are equipped with a Wilo PARA ST 25/7 iPWM2 pump.
CSE SOL G models are equipped with a Grundfos UPM3 Hybrid 25-70 pump.

CONTENTS

- 4-11** Solar Pump Stations with Controller
 - with el. socket for connecting an electric heating element
 - with el. socket for switching a heat source
 - without el. socket
- 12-13** Solar Pump Stations without Controller
- 14** Controller for Solar Pump Stations
- 15** Electric Heating Element
- 16-17** Circulation Pumps

SOLAR PUMP STATIONS WITH CONTROLLER

with el. socket to connect a heating element



CSE SOL W SRS1 T-E Pump Station

Pump Station with an integrated solar controller. The pump speed is controlled continuously by the controller and the flow rate through the solar thermal system is shown on its display. The pump station includes also a dedicated 230V power socket intended for connecting an el. heating element of up to 3kW output, or for connecting a circulation pump through a special connector. This permits to control e.g. a DHW recirculation pump or to switch another pump when an external solar heat exchanger is installed. The socket is switched following a selected program – by a temperature and time program in case of a heating element, or by a recirculation piping temperature and time program in case of DHW recirculation.

TECHNICAL DATA

MAX. WORKING PRESSURE	6 bar
MAX. WORKING TEMPERATURE	110 °C
FLOW RATE MEASUREMENT RANGE	2-20 l/min
POWER SUPPLY	230 V, 50 Hz
HEATING ELEMENT SOCKET	230 V, max 3 kW
DIMENSIONS	470 x 265 x 120 mm

COMPONENTS

- Circulation pump PARA ST 25 / 7-50 / iPWM2
- 3m power cord with el. plug for controller & pump
- **SRS1T Controller with tank sensors connected (the assembly involves 1 solar sensor and 2 tank sensors)**
- **230V power socket intended to connect an el. heating element of up to 3kW output, switched by the controller**
- Check valve
- Safety valve
- Fill and drain valves
- Two ball valves
- Pressure gauge
- Thermometer
- Safety valve waste pipe
- Expansion vessel connection point
- Thermoinsulating case

MODELS

Connections	G 3/4" M	G 1" M	Cu 18 mm	Cu 22 mm	Cu 28 mm
Code	16955	17318	18118	16956	17319

DIAGRAM

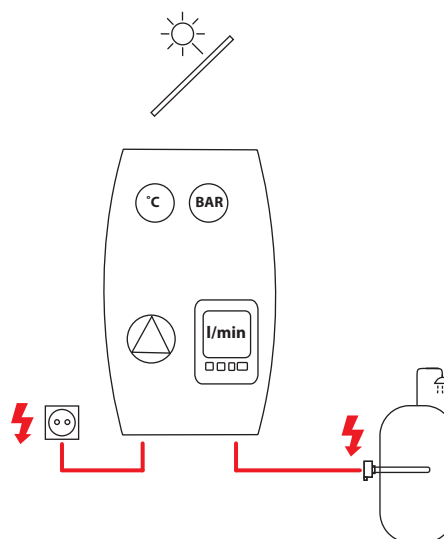

ACCESSORIES

- ETT-N heating elements – see page 15
- Connector for pump station socket - **code 16940**
- Compression fitting adaptor for connecting a waste pipe to the safety valve:
Cu 22 x Cu 22 – **code 7629**
Cu 22 x 3/4" M – **code 13695**



SOLAR PUMP STATIONS WITH CONTROLLER

with el. socket to connect a heating element



CSE SOL G SRS1 T-E Pump Station

Pump Station with an integrated solar controller. The pump speed is controlled continuously by the controller. The integrated mechanical flowmeter serves for flow rate indication only. The flow rate itself is controlled by the controller. The pump station includes also a dedicated 230V power socket intended to connect an el. heating element of up to 3kW output. The socket is switched following a selected program - by a temperature and time program in case of a heating element, or by a recirculation piping temperature and time program in case of DHW recirculation.

TECHNICAL DATA

MAX. WORKING PRESSURE	6 bar
MAX. WORKING TEMPERATURE	110 °C
POWER SUPPLY	230 V, 50 Hz
HEATING ELEMENT SOCKET	230 V, max 3 kW
DIMENSIONS	470 x 265 x 120 mm

COMPONENTS

- Circulation pump Grundfos UPM3 Hybrid 25-70
- 3m power cord with el. plug for controller & pump
- **SRS1T Controller with tank sensors connected (the assembly involves 1 solar sensor and 2 tank sensors)**
- **230V power socket intended to connect an el. heating element of up to 3kW output, switched by the controller**
- **Mechanical flowmeter**
- Check valve
- Safety valve
- Fill and drain valves
- Two ball valves
- Pressure gauge
- Thermometer
- Safety valve waste pipe
- Expansion vessel connection point
- Thermoinsulating case

MODELS

Connections	G 3/4" M	G 1" M
Flow rate measurement range	2-12 l/min	8-28 l/min
Code	18970	18962

DIAGRAM

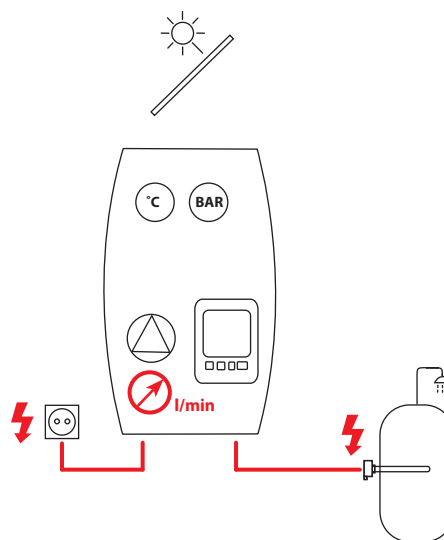

ACCESSORIES

ETT-N heating elements - see page 15

Connector for pump station socket - **code 16940**

Compression fitting adaptor for connecting a waste pipe to the safety valve:

Cu 22 x Cu 22 - **code 7629**

Cu 22 x 3/4" M - **code 13695**



SOLAR PUMP STATIONS WITH CONTROLLER

with el. socket to connect a heating element, switched by Ripple control



CSE SOL W SRS1 T-E HDO Pump Station

Pump Station with an integrated solar controller. The pump speed is controlled continuously by the controller and the flow rate through the solar thermal system is shown on its display. The pump station includes also a dedicated 230V power socket intended to connect an el. heating element of up to 3kW output. The power socket is switched by the controller depending on the storage tank temperature, time program and Ripple control.

TECHNICAL DATA

MAX. WORKING PRESSURE	6 bar
MAX. WORKING TEMPERATURE	110 °C
FLOW RATE MEASUREMENT RANGE	2-20 l/min
POWER SUPPLY	230 V, 50 Hz
HEATING ELEMENT SOCKET	230 V, max 3 kW
DIMENSIONS	470 x 265 x 120 mm

COMPONENTS

- Circulation pump PARA ST 25 / 7-50 / iPWM2
- 3m power cord with el. plug for controller & pump
- **Power cable for an el. heating element to connect to Ripple-controlled power supply**
- **SRS1T Controller with tank sensors connected (the assembly involves 1 solar sensor and 2 tank sensors)**
- **230V power socket intended to connect an el. heating element of up to 3kW output, switched by Ripple control and the controller**
- Check valve
- Safety valve
- Fill and drain valves
- Two ball valves
- Pressure gauge
- Thermometer
- Safety valve waste pipe
- Expansion vessel connection point
- Thermoinsulating case

MODELS

Connections	G 3/4" M	G 1" M	Cu 22mm	Cu 28mm
Code	17350	17349	17351	17352

DIAGRAM

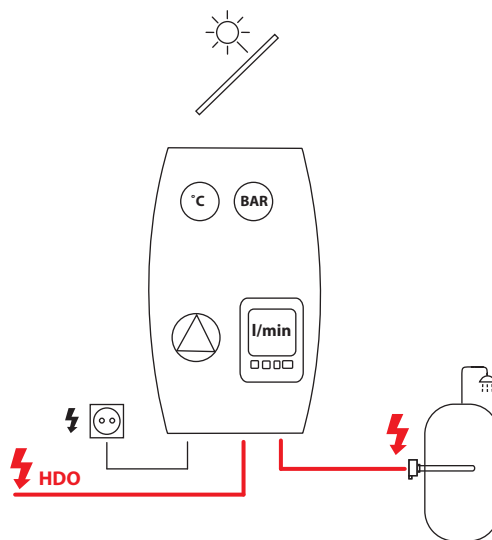

ACCESSORIES

- ETT-N heating elements - see page 15
- Compression fitting adaptor for connecting a waste pipe to the safety valve:
Cu 22 x Cu 22 - **code 7629**
Cu 22 x 3/4" M - **code 13695**



SOLAR PUMP STATIONS WITH CONTROLLER

with el. socket to connect a heating element, switched by Ripple control



CSE SOL G SRS1 T-E HDO Pump Station

Pump Station with an integrated solar controller. The pump speed is controlled continuously by the controller. The integrated mechanical flowmeter serves for flow rate indication only. The flow rate itself is controlled by the controller. The pump station includes also a dedicated 230V power socket intended to connect an el. heating element of up to 3kW output. The power socket is switched by the controller depending on the storage tank temperature, time program and Ripple control.

TECHNICAL DATA

MAX. WORKING PRESSURE	6 bar
MAX. WORKING TEMPERATURE	110 °C
POWER SUPPLY	230 V, 50 Hz
HEATING ELEMENT SOCKET	230 V, max 3 kW
DIMENSIONS	470 x 265 x 120 mm

COMPONENTS

- Circulation pump Grundfos UPM3 Hybrid 25-70
- 3m power cord with el. plug for controller & pump
- **Power cable for an el. heating element to connect to Ripple-controlled power supply**
- **SRS1T Controller with tank sensors connected (the assembly involves 1 solar sensor and 2 tank sensors)**
- **230V power socket intended to connect an el. heating element of up to 3kW output, switched by Ripple control and the controller**
- **Mechanical flowmeter**
- Check valve
- Safety valve
- Fill and drain valves
- Two ball valves
- Pressure gauge
- Thermometer
- Safety valve waste pipe
- Expansion vessel connection point
- Thermoinsulating case

MODELS

Connections	G 3/4" M	G 1" M
Flow rate measurement range	2-12 l/min	8-28 l/min
Code	18968	18964

DIAGRAM

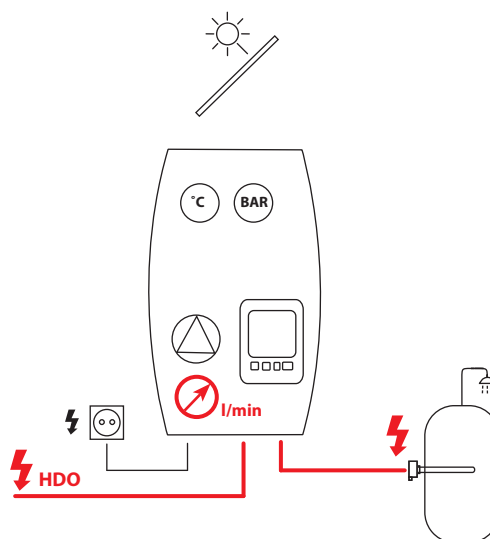

ACCESSORIES

- ETT-N heating elements – see page 15
- Compression fitting adaptor for connecting a waste pipe to the safety valve:
Cu 22 x Cu 22 – **code 7629**
Cu 22 x 3/4" M – **code 13695**



SOLAR PUMP STATIONS WITH CONTROLLER

with el. socket to switch an aux. heat source



CSE SOL W SRS1 T-K Pump Station

Pump Station with an integrated solar controller. The pump speed is controlled continuously by the controller and the flow rate through the solar thermal system is shown on its display. The pump station includes also a dedicated power socket intended for switching an auxiliary heat source by a potential-free contact. The heat source is switched by the controller depending on the storage tank temperature and time program. A cable for connecting the aux. heat source is included in supply.

TECHNICAL DATA

MAX. WORKING PRESSURE	6 bar
MAX. WORKING TEMPERATURE	110 °C
FLOW RATE MEASUREMENT RANGE	2-20 l/min
POWER SUPPLY	230 V, 50 Hz
HEAT SOURCE SWITCHING	potential-free contact
MAX. SWITCHED CURRENT	13 A
DIMENSIONS	470 x 265 x 120 mm

COMPONENTS

- Circulation pump PARA ST 25 / 7-50 / iPWM2
- 3m power cord with el. plug for controller & pump
- **SRS1T Controller with tank sensors connected (the assembly involves 1 solar sensor and 2 tank sensors)**
- **Socket for switching an auxiliary heat source (boiler)**
- **Cable with connector, to control a heat source**
- Check valve
- Safety valve
- Fill and drain valves
- Two ball valves
- Pressure gauge
- Thermometer
- Safety valve waste pipe
- Expansion vessel connection point
- Thermoinsulating case

MODELS

Connections	G 3/4" M	G 1" M	Cu 18mm	Cu 22mm	Cu 28mm
Code	17899	17898	18119	17900	17901

DIAGRAM

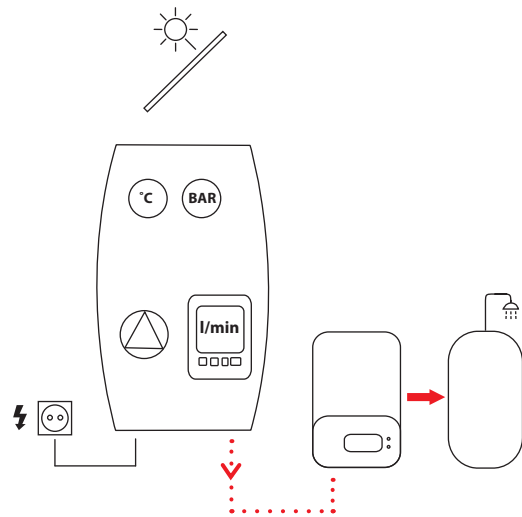

ACCESSORIES

Compression fitting adaptor for connecting a waste pipe to the safety valve:

Cu 22 x Cu 22 - **code 7629**

Cu 22 x 3/4" M - **code 13695**



SOLAR PUMP STATIONS WITH CONTROLLER

with el. socket to switch an aux. heat source



CSE SOL G SRS1 T-K Pump Station

Pump Station with an integrated solar controller. The pump speed is controlled continuously by the controller. The integrated mechanical flowmeter serves for flow rate indication only. The flow rate itself is controlled by the controller. The pump station includes also a dedicated power socket intended for switching an auxiliary heat source by a potential-free contact. The heat source is switched by the controller depending on the storage tank temperature and time program. A cable for connecting the aux. heat source is included in supply.

TECHNICAL DATA

MAX. WORKING PRESSURE	6 bar
MAX. WORKING TEMPERATURE	110 °C
POWER SUPPLY	230 V, 50 Hz
HEAT SOURCE SWITCHING	potential-free contact
MAX. SWITCHED CURRENT	13 A
DIMENSIONS	470 x 265 x 120 mm

COMPONENTS

- Circulation pump Grundfos UPM3 Hybrid 25-70
- 3m power cord with el. plug for controller & pump
- **SRS1T Controller with tank sensors connected (the assembly involves 1 solar sensor and 2 tank sensors)**
- **Socket for switching an auxiliary heat source (boiler)**
- **Cable with connector, to control a heat source**
- **Mechanical flowmeter**
- Check valve
- Safety valve
- Fill and drain valves
- Two ball valves
- Pressure gauge
- Thermometer
- Safety valve waste pipe
- Expansion vessel connection point
- Thermoinsulating case

MODELS

Connections	G 3/4" M	G 1" M
Flow rate measurement range	2-12 l/min	8-28 l/min
Code	18971	18966

DIAGRAM

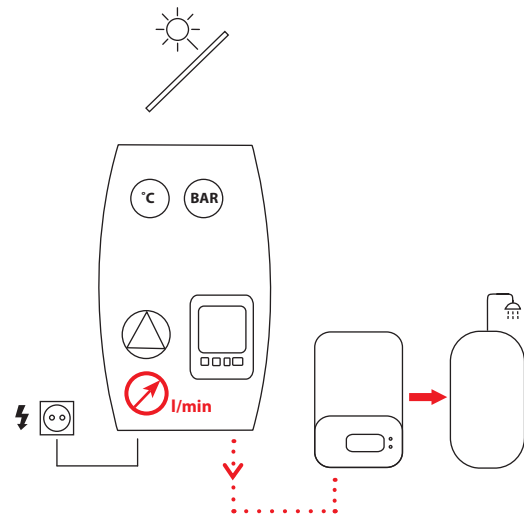

ACCESSORIES

Compression fitting adaptor for connecting a waste pipe to the safety valve:
Cu 22 x Cu 22 - **code 7629**
Cu 22 x 3/4" M - **code 13695**



SOLAR PUMP STATIONS WITH CONTROLLER



CSE SOL W SRS1T Pump Station

Pump Station with an integrated solar controller. The pump speed is controlled continuously by the controller and the flow rate through the solar thermal system is shown on its display.

TECHNICAL DATA

MAX. WORKING PRESSURE	6 bar
MAX. WORKING TEMPERATURE	110 °C
FLOW RATE MEASUREMENT RANGE	2-20 l/min
POWER SUPPLY	230 V, 50 Hz
DIMENSIONS	470 x 265 x 120 mm

DIAGRAM

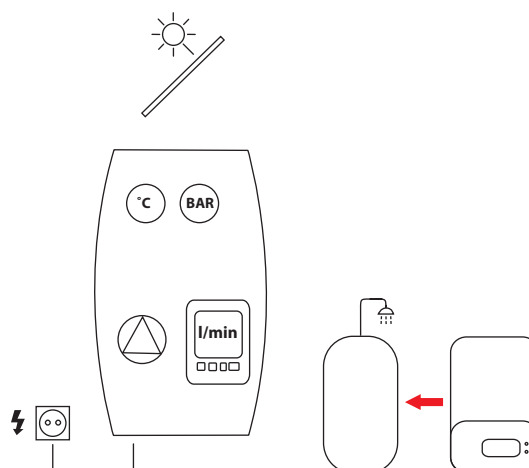

COMPONENTS

- Circulation pump PARA ST 25 / 7-50 / iPWM2
- 3m power cord with el. plug for controller & pump
- **SRS1T Controller with tank sensors connected (the assembly involves 1 solar sensor and 1 tank sensor)**
- Check valve
- Safety valve
- Fill and drain valves
- Two ball valves
- Pressure gauge
- Thermometer
- Safety valve waste pipe
- Expansion vessel connection point
- Thermoinsulating case

ACCESSORIES

Compression fitting adaptor for connecting a waste pipe to the safety valve:
 Cu 22 x Cu 22 - **code 7629**
 Cu 22 x 3/4" M - **code 13695**



MODELS

Connections	G 3/4" M	G 1" M	Cu 18 mm	Cu 22 mm	Cu 28 mm
Code	17726	17902	18117	17903	17904

SOLAR PUMP STATIONS WITH CONTROLLER



CSE SOL G SRS1T Pump Station

Pump Station with an integrated solar controller. The pump speed is controlled continuously by the controller. The integrated mechanical flowmeter serves for flow rate indication only. The flow rate itself is controlled by the controller.

TECHNICAL DATA

MAX. WORKING PRESSURE	6 bar
MAX. WORKING TEMPERATURE	110 °C
POWER SUPPLY	230 V, 50 Hz
DIMENSIONS	470 x 265 x 120 mm

COMPONENTS

- Circulation pump Grundfos UPM3 Hybrid 25-70
- 3m power cord with el. plug for controller & pump
- **SRS1T Controller with tank sensors connected (the assembly involves 1 solar sensor and 2 tank sensors)**
- **Mechanical flowmeter**
- Check valve
- Safety valve
- Fill and drain valves
- Two ball valves
- Pressure gauge
- Thermometer
- Safety valve waste pipe
- Expansion vessel connection point
- Thermoinsulating case

MODELS

Connections	G 3/4" M	G 1" M
Flow rate measurement range	2-12 l/min	8-28 l/min
Code	18969	18960

DIAGRAM

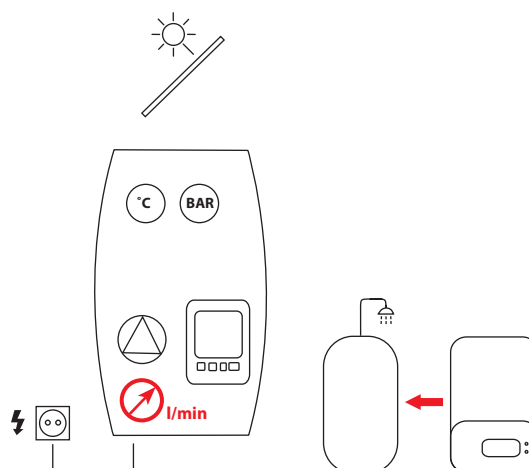

ACCESSORIES

Compression fitting adaptor for connecting a waste pipe to the safety valve:
 Cu 22 x Cu 22 - **code 7629**
 Cu 22 x 3/4" M - **code 13695**



SOLAR PUMP STATIONS WITHOUT CONTROLLER

- for controllers with PWM control



CSE SOL W P Pump Station

Pump station for externally controlled solar thermal system. The pump is controlled by PWM signal, permitting to send the flow rate information via iPWM signal back to controller. The flow rate is indicated on a mechanical flowmeter.

TECHNICAL DATA

MAX. WORKING PRESSURE	6 bar
MAX. WORKING TEMPERATURE	110 °C
POWER SUPPLY	230 V, 50 Hz
DIMENSIONS	470 x 265 x 120 mm

COMPONENTS

- Circulation pump PARA ST 25 / 7-50 / iPWM2 with power supply and PWM & iPWM signal cables
- **Mechanical flowmeter**
- Check valve
- Safety valve
- Fill and drain valves
- Two ball valves
- Pressure gauge
- Thermometer
- Safety valve waste pipe
- Expansion vessel connection point
- Thermoinsulating case

MODELS

Connections	G 3/4" M	G 1" M
Flow rate measurement range	2-12 l/min	8-28 l/min
Code	17155	17325

DIAGRAM

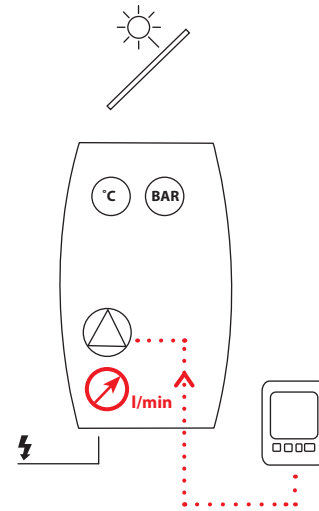

SOLAR PUMP STATIONS WITHOUT CONTROLLER

- for controllers with PWM control or 230V switching (ON/OFF)



CSE SOL G P Pump Station

Pump station for externally controlled solar thermal system. The pump is controlled by PWM signal or 230V switching (ON/OFF). The flow rate is indicated on a mechanical flowmeter.

TECHNICAL DATA

MAX. WORKING PRESSURE	6 bar
MAX. WORKING TEMPERATURE	110 °C
POWER SUPPLY	230 V, 50 Hz
DIMENSIONS	470 x 265 x 120 mm

COMPONENTS

- Circulation pump Grundfos UPM3 Hybrid 25-70 with power supply and PWM signal cables
- **Mechanical flowmeter**
- Check valve
- Safety valve
- Fill and drain valves
- Two ball valves
- Pressure gauge
- Thermometer
- Safety valve waste pipe
- Expansion vessel connection point
- Thermoinsulating case

MODELS

Connections	G 3/4" M	G 1" M
Flow rate measurement range	2-12 l/min	8-28 l/min
Code	18958	18957

DIAGRAM

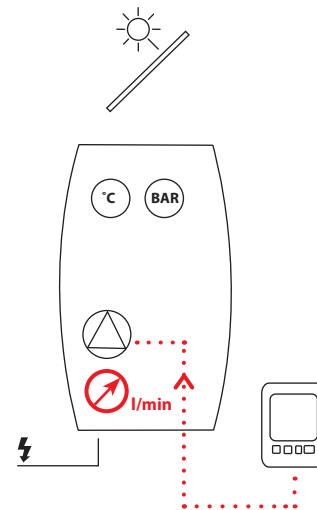

ACCESSORIES

Compression fitting adaptor for connecting a waste pipe to the safety valve:

Cu 22 x Cu 22 - **code 7629**

Cu 22 x 3/4" M - **code 13695**



PUMP STATION CONTROLLER

Hydraulic variants with CSE SOL pump stations



Controller SRS1T

3-sensor controller for use with solar thermal systems with 1 collector array and 1 solar consumer, with potential-free contact to switch a boiler or el. heating element of up to 3 kW power input, with a PWM/0-10V output and iPWM input for establishing the circulation pump flow rate.

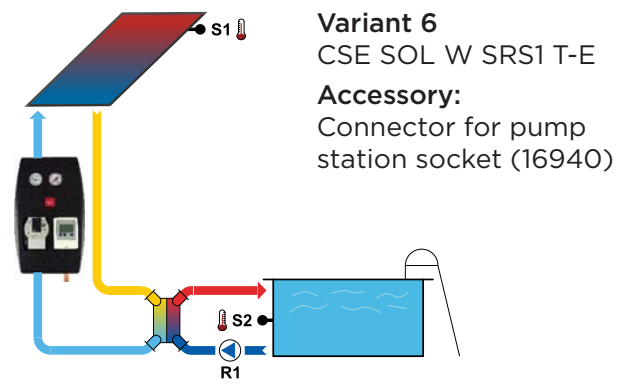
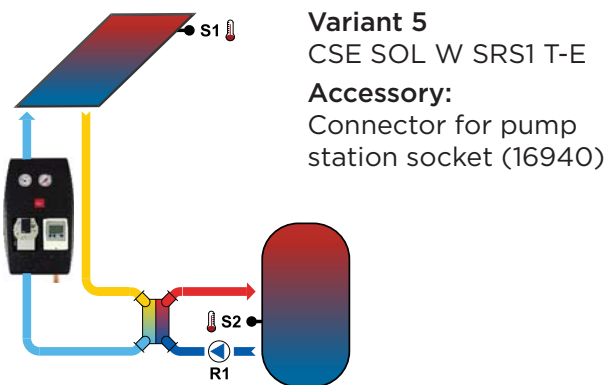
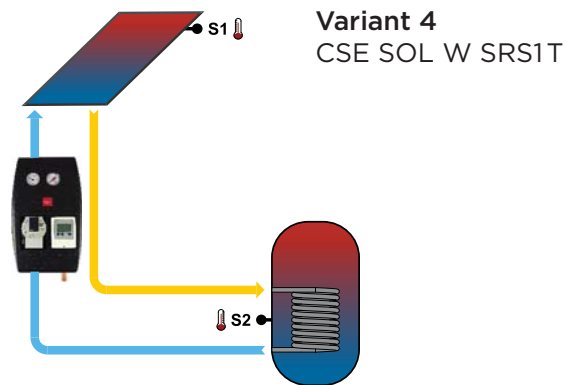
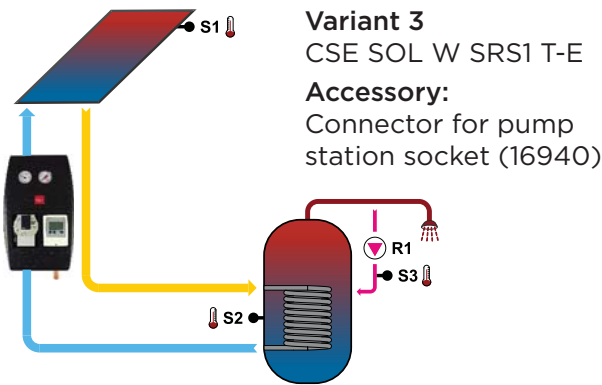
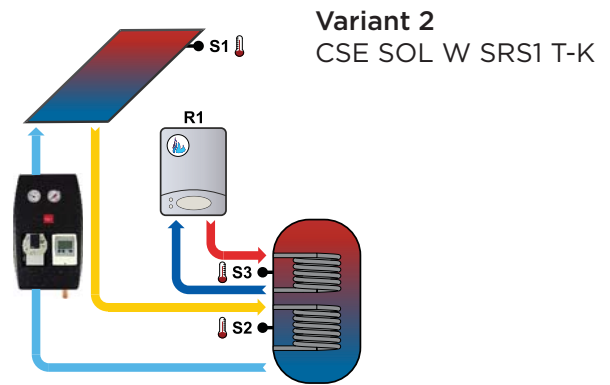
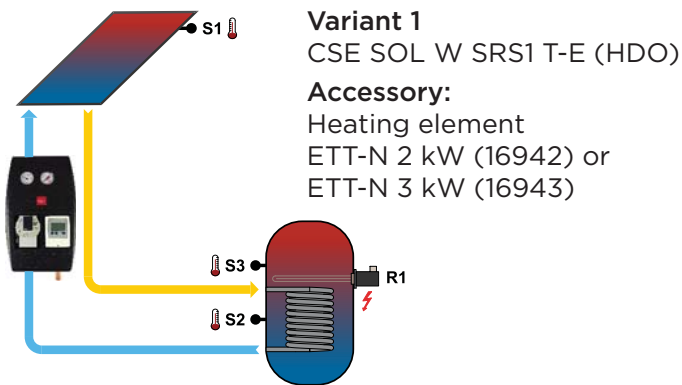

ELECTRIC HEATING ELEMENTS, G 6/4"

with a switch and safety thermostat, for CSE SOL SRS1 T-E (HDO)



ETT-N Electric Heating Elements

These heating elements are **nickel-plated** and are suitable for installation into steel thermal stores with heating water, **hot water storage tanks and combination thermal stores**. They are intended for installation and operation in sealed hydronic systems, in horizontal position only, with the complete heating section safely immersed in water, incl. the non-heating end.

The long non-heating end ensures a better heat transfer, without formation of sediments close to the heating element threads. These elements are not intended for stainless steel thermal stores or hot water storage tanks. They shall be installed with the cable gland downwards.

The connector of these heating elements permits a direct and simple connection into a dedicated power socket integrated in CSE SOL SRS1 T-E or CSE SOL SRS1 T-E HDO solar pump stations. These heating elements are fitted with a power switch with a LED indicator and a safety thermostat.

TECHNICAL DATA

HEATING ELEMENT	nickel-plated copper
CONNECTING THREAD	G 6/4" M
HEXAGON WITH G 6/4" THREAD	nickel-plated brass
BOX	PC, flame rating UL94-5V
POWER SUPPLY	230V 50 Hz
PROTECTION CLASS BY EN 61140 ed.2	I
SAFETY THERMOSTAT	w. capillary, fixed temperature
SWITCH-OFF TEMPERATURE	99 +/-10 °C
RESET	manual, after temperature drop below 40 °C
CABLE	
CROSS SECTION	3x 1.5 mm ²
LENGTH	5 m

DIMENSIONS, MODELS

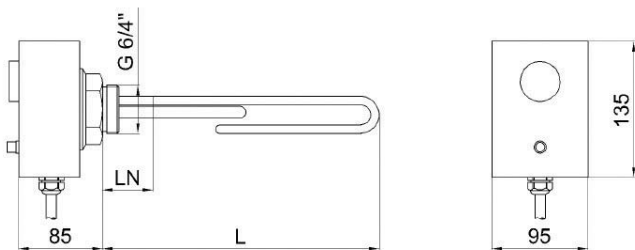

The heating elements have a longer non-heating end (dimension LN) that permits use also in combination thermal stores.

MODEL		ETT-N 2.0	ETT-N 3.0
NOMINAL OUTPUT	kW	2.0	3.0
NOMINAL CURRENT	A	8,7	13,0
ELEMENT LENGTH (L)	mm	350	450
NON-HEATING END LENGTH (LN)	mm	180	180
CODE	--	16942	16943

EL. WIRING

1/N/PE AC 230V

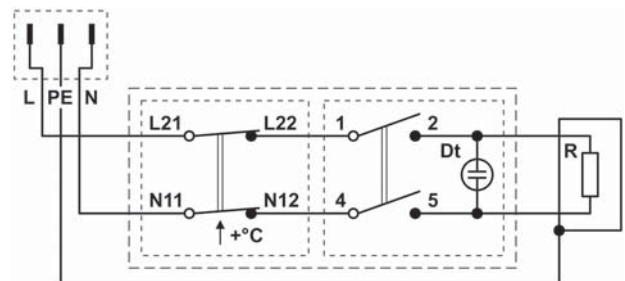

CIRCULATION PUMP IN PUMP STATIONS



High Efficiency Circulation Pump WILO PARA ST 25 / 7-50 / iPWM2

A high efficiency wet-running circulation pump that is installed in all CSE SOL W solar pump stations. Thanks to PWM signal control it allows a continuous reduction of its output and energy consumption, increasing thus the efficiency of the solar thermal system.

It sends the information on the solar fluid flow rate through the pump to the solar controller by means of the iPWM signal. The pump can be controlled only by a controller with a PWM output, with a PWM-solar type of signal (normal PWM profile).

TECHNICAL DATA

ENERGY EFFICIENCY INDEX (EEI)	≤ 0.20
TEMPERATURE OF CONVEYED FLUID	-10 °C to +110 °C
POWER SUPPLY	1-230 V, 50 Hz
PORT-TO-PORT LENGTH	130 mm
CONNECTING THREAD	G 6/4" M
MAX. WORKING PRESSURE	10 bar
POWER INPUT	1.8 - 50 W

PUMP CHARACTERISTICS

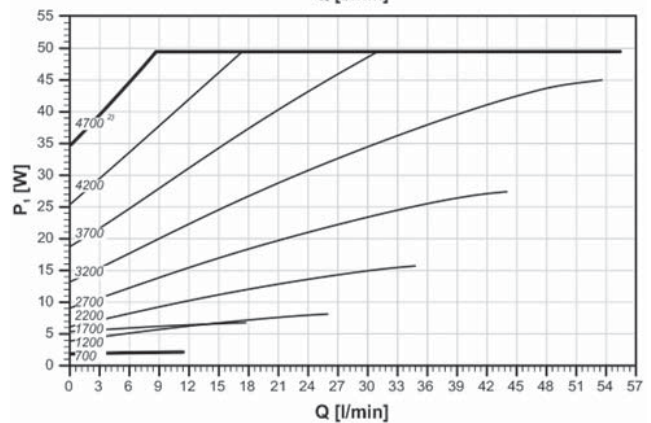
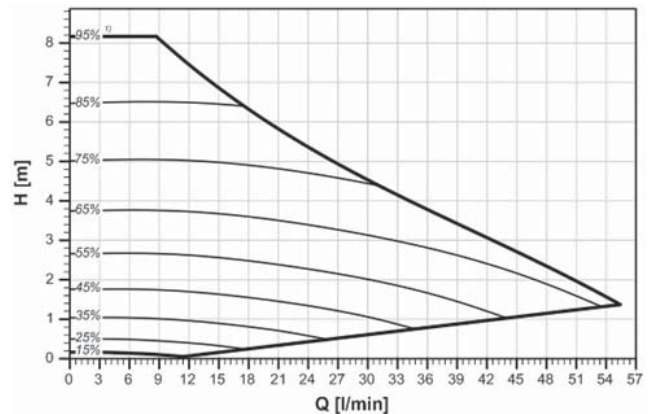

NOTES:

- 1) PWM signal value in %
- 2) speed in rpm

CIRCULATION PUMP IN PUMP STATIONS



High Efficiency Circulation Pump UPM3 HYBRID 25-70 130 mm

A high efficiency wet-running circulation pump that is installed in all CSE SOL G solar pump stations. Thanks to PWM signal control it allows a continuous reduction of its output and energy consumption, increasing thus the efficiency of the solar thermal system.

This circulation pump can be controlled even without the PWM signal by selecting either the constant pressure mode (pressure of 1.5-3-4.5 m) or the constant speed mode (pressure of up to 7 m) - see the graph on the right. The proportional pressure mode is not suitable for solar thermal systems.

TECHNICAL DATA

ENERGY EFFICIENCY INDEX (EEI)	≤ 0.20
TEMPERATURE OF CONVEYED FLUID	-10 °C to +110 °C
POWER SUPPLY	1-230 V, 50 Hz
PORT-TO-PORT LENGTH	130 mm
CONNECTING THREAD	G 6/4" M
MAX. WORKING PRESSURE	10 bar
POWER INPUT	2 - 52 W

PUMP CHARACTERISTICS

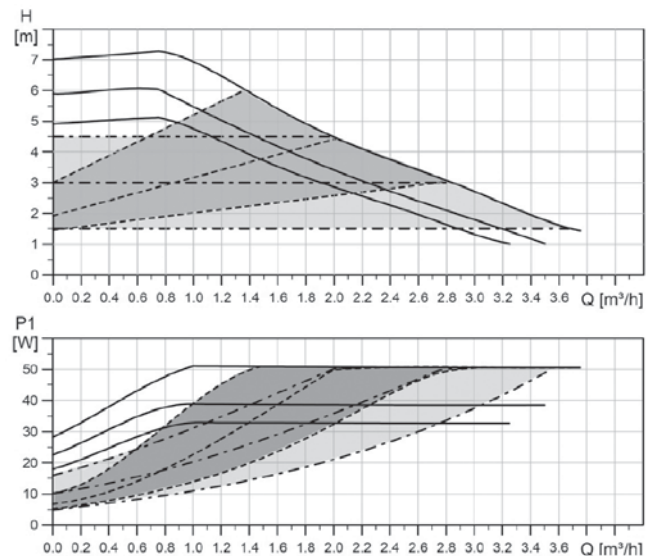

Line	Description
—	Constant speed
- - - -	Proportional pressure
- · - · -	Constant pressure



