

Installation, Wiring and Operation Instructions

## REGULUS SRS3 E Controller



CE

EN  
v. 1.2

**Regulus**

# CONTENTS

## A. - Safety Instructions

- A.1 EC Declaration of Conformity
- A.2 General information
- A.3 Explanation of symbols
- A.4 Changes to the unit

## B. - Description

- B.1 Specification
- B.2 Temperature resistance table for Pt1000 sensors:
- B.3 Description
- B.4 Scope of supply
- B.5 Disposal

## C. - Installation

- C.1 Wall installation
- C.2 Electrical wiring
- C.3 Installing the temperature sensors

## D. Terminal block wiring

- D.1 Hydraulic variants

## E. - Operation

- E.1 Display and input
- E.2 Commissioning help
- E.3 Free commissioning
- E.4 Menu sequence and menu structure

## 1. - Measurements

### 2. - Statistics

- 2.1. - Operating hours
- 2.2. - Heat output
- 2.3. - Graphic overview
- 2.4. - Message log
- 2.5. - Reset/Clear

### 3. - Operating modes

- 3.1. - Auto
- 3.2. - Manual
- 3.3. - Off

### 4. - Settings

- 4.1. - Tmin S1
- 4.3. - Priority Storage 1
- 4.4. -  $\Delta T1 / \Delta T$  (pool)
- 4.5. - Tmax S2
- 4.6. - Priority Storage 2
- 4.7. -  $\Delta T2$
- 4.8. - Tmax S3
- 4.13. - Tmax pool
- 4.14. - Tmax pool HE
- 4.15. - Priority temperature
- 4.16. - Loading time
- 4.17. - Increase

### 5. - System protection

- 5.1. - System protection
- 5.2. - Collector protection
- 5.3. - Recooling
- 5.4. - Frost protection
- 5.5. - Seizing protection
- 5.6. - Collector alarm

### 6. - Special functions

- 6.1. - Program selections

4	6.2. - Pump settings V1	24
4	6.2.1. - Type of pump	24
4	6.2.2. - Pump	24
4	6.2.3. - Output signal	24
5	6.2.4. - 0-10V / PWM Off	25
	6.2.5. - 0-10V / PWM On	25
6	6.2.6. - 0-10V / PWM Max	25
6	6.2.7. - Show signal	25
6	6.3. - Speed control	26
7	6.3.1. - Modes	26
7	6.3.2. - Purging time	27
7	6.3.3. - Sweep time	27
	6.3.4. - Max. speed	27
8	6.3.5. - Min. speed	27
8	6.3.6. - Setpoint	27
9	6.3.7. - Temperature difference	27
10	6.5. - Relay functions	28
	6.5.1. - Solar bypass	28
11	6.5.2. - Thermostat	29
12	6.5.3. - Cooling	30
	6.5.4. - Return flow increase	30
14	6.5.5. - Collector cooling	31
14	6.5.6. - Anti Legionella	32
15	6.5.7. - Heat transfer	33
15	6.5.8. - Difference	34
16	6.5.9. - Solid fuel boiler	35
	6.5.10. - Error message	35
16	6.5.11. - Booster pump	35
	6.5.12. - Parallel operation R (X)	36
17	6.5.13. - Always on	36
17	6.5.14. - Heating circuit	36
17	6.6. - Heat quantity	37
17	6.6.1. - Constant flow rate	37
17	6.6.2. - Flow sensor	37
17	6.6.3. - Return flow	37
	6.6.4. - Antifreeze type	37
18	6.6.5. - Glycol percentage	37
18	6.6.6. - Flow rate	37
18	6.6.7. - $\Delta T$ Offset	37
18	6.7. - Sensor calibration	38

19	6.8. - Commissioning	38
----	----------------------	----

19	6.9. - Factory settings	38
----	-------------------------	----

19	6.10. - Start aid function	38
----	----------------------------	----

19	6.11. - Time and Date	39
----	-----------------------	----

20	6.12. - Daylight saving time	39
----	------------------------------	----

20	6.13. - Sleep mode	39
----	--------------------	----

20	6.14. - Temperature unit	39
----	--------------------------	----

20	6.15. - Network	39
----	-----------------	----

20	6.15.1. - Access control	39
----	--------------------------	----

21	6.15.2. - Ethernet	39
----	--------------------	----

21	7. - Menu lock	40
----	----------------	----

22	8. - Service values	41
----	---------------------	----

22	9. - Language	42
----	---------------	----

23	Z. - Malfunctions, additional info	43
----	------------------------------------	----

23	Z.1. Malfunctions with error messages	43
----	---------------------------------------	----

23	Z.2. Replacing the fuse	44
----	-------------------------	----

23	Z.3. Maintenance	45
----	------------------	----

23	Z.4. CAN bus	46
----	--------------	----

24	Tips & Tricks	47
----	---------------	----

24		
----	--	--

**This Instruction Manual applies to the following hardware version:  
SRS3 E v. 5, September 2015**

**SRS3 E**

2 output mechanical relays 230VAC  
1 PWM/0-10V output for high efficiency pumps  
4 inputs for Pt1000 temperature sensors

# Safety Instructions

## A.1 EC Declaration of Conformity

The manufacturer declares that a Declaration of Conformity has been issued for the SRS3 T Solar Controller, it is marked with the CE mark and conforms to the following relevant safety regulations:

- Directive 2014/35/EU - EC low voltage directive
- Directive 2014/30/EU - EC electromagnetic compatibility directive

## A.2 General information

**- please read carefully!**

These installation and operating instructions contain basic instructions and important information regarding safety, installation, commissioning, maintenance and the optimal use of the unit. Therefore these instructions must be read completely and understood by the installation technician/specialist and by the system user before installing, commissioning and operating the unit. The installation shall be done in compliance with valid standards and rules. The controller does not under any circumstances replace any safety devices (e.g. safety valve, air vent valve etc.) to be installed into a solar circuit! Installation of the unit may only be carried out by a specialist who is trained on the required level.

**For the user:** Make sure that the specialist gives you detailed information on the function and operation of the controller. Always keep these instructions in the vicinity of the controller. Any changes to the controller or tampering with may pose a risk to safe operation of the appliance and to the complete solar thermal system.

## A.3 Explanation of symbols



*Failure to observe these instructions can result in danger to life from electric voltage.*



*Failure to observe these instructions can result in serious damage to health such as scalding, or even life-threatening injuries.*



*Failure to observe these instructions can result in destruction of the unit or the system, or damage to the environment.*



*Information especially important for the function and optimal use of the unit and the system.*

# Safety Instructions

## A.4 Changes to the unit

- Changes, additions to or conversion of the unit are not permitted without a written permission from the Manufacturer.
- It is forbidden to install any additional components into the controller that has not been tested together with the controller.
- The controller shall not be used after an accident when its functions may have been affected – e.g. after a fire. The controller shall be switched off immediately.
- Use original spare parts only.
- Marking of the Manufacturer and Distributor shall not be altered or removed.
- All adjustments shall be done in compliance with this Guide.

## A.5 Warranty

The controller has been manufactured and tested with regard to high quality and safety requirements. The unit is subject to the statutory guarantee period of two years from the date of sale.

The warranty and liability shall not include, however, any injury to persons or material damage that is attributable to one or more of the following causes:

- Failure to observe these installation and operating instructions
- Improper installation, commissioning, maintenance and operation
- Improperly executed repairs
- Unauthorised structural changes to the unit
- Installation of additional components that have not been tested together with the unit
- Any damage resulting from continued use of the unit despite an obvious defect
- Failure to use original spare parts and accessories
- Use of the device for other than its intended purpose
- Operation above or below the limit values listed in the specifications
- Force majeure

# Description

## B.1 Specification

### Electric specification:

Voltage	230VAC +/- 10%
Mains frequency	50 - 60Hz
Power consumption	0,5W - 2,5W

Internal fuse T2A / 250V slow blow

IP rating	IP40
El. protection class	II
Overvoltage category	II
Pollution degree	II

	SRS3 E
Mechanical relay, 460VA (AC1), 460W /AC3)	2 (R1/R2)
0-10V output, 10% tolerance, 10 kΩ, or PWM output, 1kHz, 10V	1 (V1)
Pt1000 sensors, from -40 °C to +300 °C	4 (S1 - S4)

### Network connection CAN Bus

### Permissible cable length of sensors and accessories:

Collector and outdoor temp. sensors	<30 m
other Pt1000 sensors	<10 m
PWM / 0...10V	<3 m
Mechanical relay	<10 m

**Clock backup period** 24 hod

### Permissible ambient conditions:

Ambient temperature:	
for controller operation	0°C - 40 °C
for transport/storage	0°C - 60 °C
Air humidity:	
for controller operation	max. 85% rel. humidity at 25 °C
for transport/storage	no moisture condensation permitted

### Other specifications and dimensions:

Housing design	3-part, ABS plastic
Installation methods	wall installation, optionally panel installation
Overall dimensions	163x110x52 mm
Installation aperture dimensions	157x106x31 mm
Display	fully graphic display, 128 x 64
LED	multicolour red/green
Operation	4 entry keys

## B.2 Temperature resistance table for Pt1000 sensors:

°C	0	10	20	30	40	50	60	70	80	90	100
Ω	1000	1039	1077	1116	1155	1194	1232	1270	1308	1347	1385

# Description

## B.3 Description

SRS3 Controller is designed for automatic control of solar thermal systems. The SRS3 E model is intended to control solar systems with up to 2 independent solar arrays and one or two solar consumers. The solar consumer can be a hot water storage tank, a heat exchanger for a swimming pool, and a thermal store for heating. All hydraulic variants are described in Chapter D.1.

- both graphics and texts on a backlit display
- simple viewing of the current measurement values
- approximate solar heat measurement
- analysis and monitoring of the system also by means of statistical graphics
- extensive setting menus with explanations
- menu lock can be activated to prevent unintentional setting changes
- usual preset parameters in factory setting
- further measurement and switching applications using a temperature difference and a thermostat function

## B.4 Scope of supply

- SRS3 E Controller
- 3 screws 3.5 × 35 mm and 3 dowels 6 mm diam. for wall installation
- 6 strain relief clips with 12 screws
- replacement fuse T2A/250V
- 3 Pt1000 temperature sensors

## B.5 Disposal

### IMPORTANT INFORMATION ON DISPOSAL IN COMPLIANCE WITH THE EUROPEAN DIRECTIVE 2002/96/ES

European Directive 2002/96/EC requires that the equipment bearing this symbol on the product and/or its packaging must not be disposed of with unsorted municipal waste. The symbol indicates that this product should be disposed of separately from regular household waste streams. It is your responsibility to dispose of this and other electric and electronic equipment via designated collection facilities appointed by the government or local authorities. Correct disposal and recycling will help prevent potential negative consequences to the environment and human health. For more detailed information about the disposal of your old equipment, please contact your local authorities, waste disposal service, or the shop where you purchased the product.



WEEE registration number:  
02771/07-ECZ

# Installation

## C.1 Wall installation



Install the controller in dry areas only.

### C.1.1

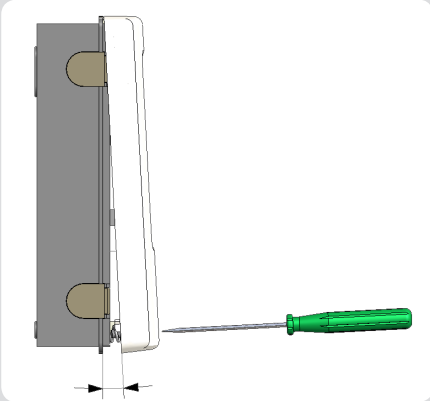

Installation instructions:

1. Unscrew cover screw completely.
2. Carefully pull the upper part of housing from the lower part, see Fig. C.1.1.
3. Set the upper part of the housing aside, being sure not to touch the electronics when doing so.
4. Hold the lower part of the housing up to the selected position and mark the 3 mounting holes. Make sure that the wall surface is as even as possible so that the housing does not become distorted when it is screwed on.
5. TMark the position on the wall with a pencil. Using a drill and size 6 bit, drill 3 holes at the points marked on the wall and push in the plugs. Fig. C 1.2.
6. Insert the upper screw and screw it in slightly.
7. Fit the upper part of the housing and insert the other two screws.
8. Align the housing and tighten the three screws.

### C.1.2

3x 3,5 x 30

3x Ø6

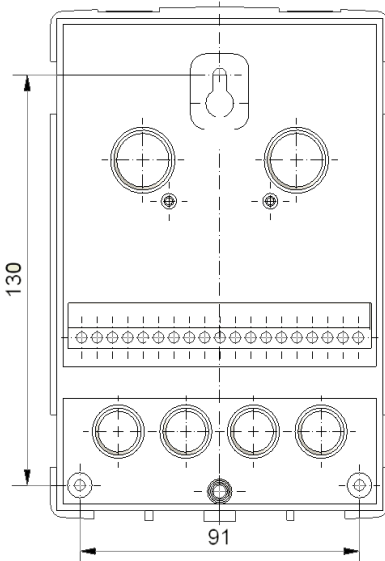



# Installation

## C.2 Electrical Wiring



Before working on the unit, switch off the power supply and secure it against being switched on again! Check for the absence of power! Electric wiring may only be done by a specialist in compliance with valid rules. Do not use the controller if its case shows visible damage.



Low-voltage cables such as temperature sensor cables must be routed separately from mains voltage cables. Feed temperature sensor cables only into the left-hand side of the unit, and mains voltage and relay cables only into the right-hand side.



The controller is not equipped with a mains switch. For this purpose please use e.g. a circuit breaker.



The cables being connected to the unit must not be stripped by more than 55 mm, and the cable jacket must reach into the housing just to the other side of the strain relief.

# Installation

C.2.1

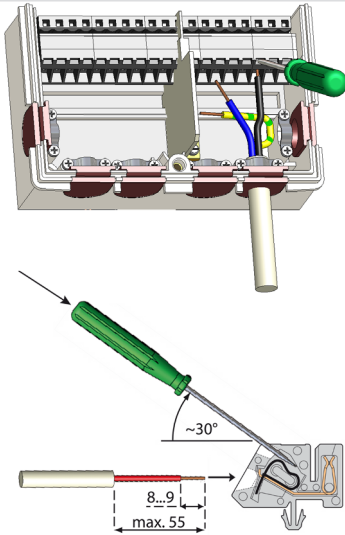

## C 2. 1 Wiring instructions:

1. Select the necessary hydraulic variant (D.1 - Hydraulic variants).
2. Open the controller as described in C.1.
3. Strip the cable by 55 mm max., insert and fit the cable strain relief. Strip the last 8-9 mm of all the wires (Fig. C.2.1).
4. Open the terminals using a flat screwdriver (Fig. C.2.1.) and wire the leads following the diagram.
5. Refit the upper housing part and fasten with screw.
6. Switch on mains voltage and place controller in operation.

C.2.2

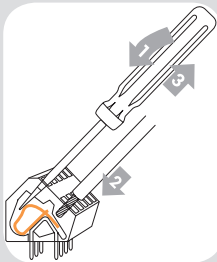

Instructions for clamps:

1. Insert screwdriver into the upper hole. Push the lock clamp inside down. Keep the screwdriver in this position.
2. Insert the stripped cable into the lower opening.
3. Remove screwdriver. The clamp will lock the cable.

## C.3 Installing the temperature sensors

The controller operates with Pt1000 temperature sensors.



Caution

Max. sensor lead length for S1 and S5 is 30 m and its cross section at least 0.75 mm<sup>2</sup>. Max. sensor lead length for S2 to S4 is 10 m and its cross section at least 0.75 mm<sup>2</sup>. Make sure there is no contact resistance in the wiring!

Select the proper location for the sensor where it feels the right temperature.

Use only immersion sensors. Pipe-mounted sensors only in exceptional cases.

Make sure that the terminals of extension cables and sensors are properly tightened.



Warning

The temperature sensor cables must be routed separately from mains voltage cables!



Warning

When connecting high efficiency pumps with PWM, it is necessary to respect the right wiring (i.e. the terminal "PWM out" on the controller with "PWM in" on the pump, and "GND" on the controller with "GND" on the pump).

# Installation

## D. - Terminal block wiring



Sensor connection  
– max. 12V



Mains voltage  
230V

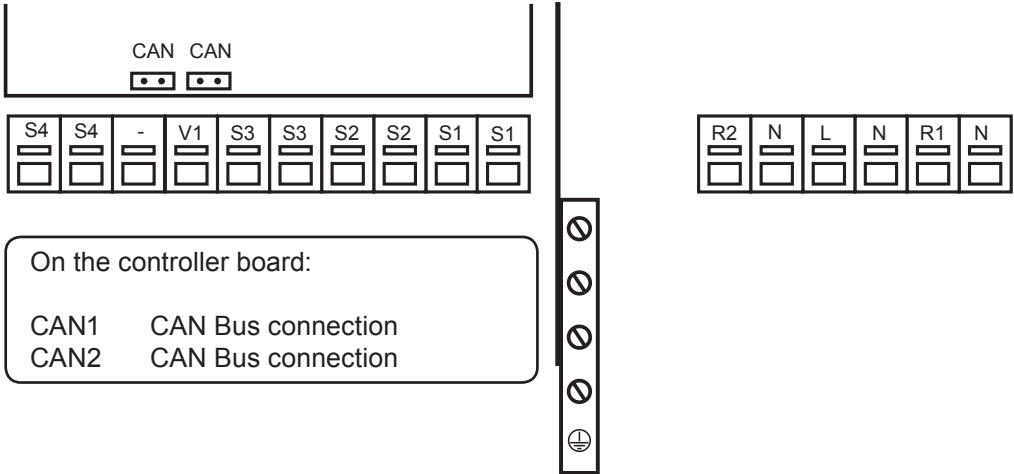

On the controller board:

CAN1 CAN Bus connection  
CAN2 CAN Bus connection



Sensor connection  
– max. 12V



Mains voltage  
230V

**Extra low voltage**, max. 12V– sensors

Terminal: connection for:

S1	sensor 1
S1	sensor 1 (GND)
S2	sensor 2
S2	sensor 2 (GND)
S3	sensor 3
S3	sensor 3 (GND)
V1	0-10V/PWM output for high efficiency pumps
-	output for 0-10V gnd. / PWM for high efficiency pumps
S4	sensor 4
S4	sensor 4 (GND)

**Mains voltage** 230V 50Hz

Terminal: connection for:

N	neutral N
R1	relay R1
N	neutral N
L	mains phase L
N	neutral N
R2	relay R2

PE protective conductor (green-yellow)

# Description

## D.1 Hydraulic variants



**Warning**

The following illustrations should be viewed only as schematic diagrams showing the respective hydraulic systems, and do not claim to be complete. The controller does not replace safety devices under any circumstances. Depending on the specific application, additional system components and safety components may be mandatory, such as check valves, safety temperature limiters, scalding protectors etc., and must therefore be provided.

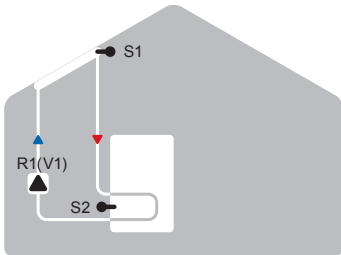

Solar with hot water storage tank

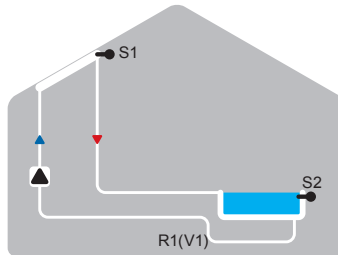

Solar with pool

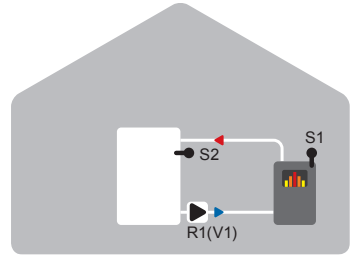

Solid fuel boiler with hot water storage tank

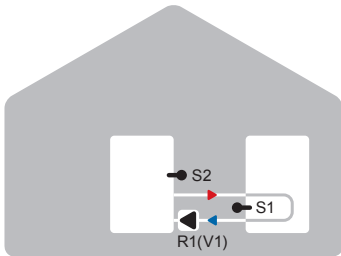

Heat transfer between hot water storage tanks

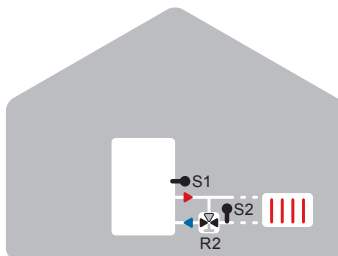

Solar with heating circuit

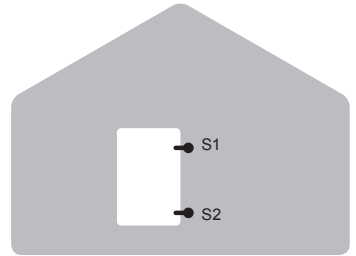

Thermostat



Universal  $\Delta T$

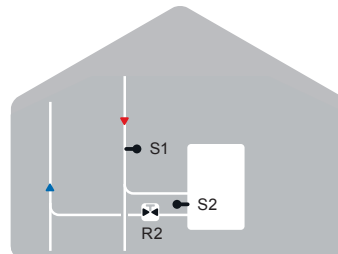

Shutoff valve

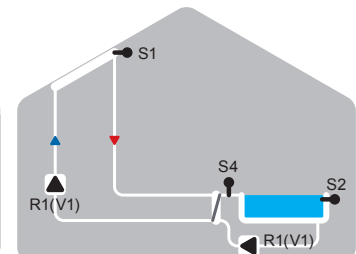

Solar with pool and heat exchanger

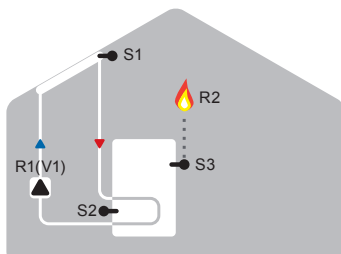

Solar with thermostat (auxiliary heating)

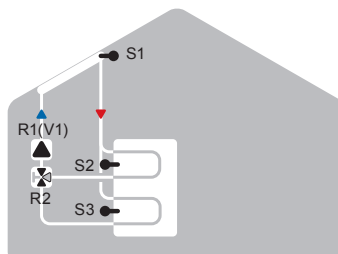

Solar with thermally stratified storage tank

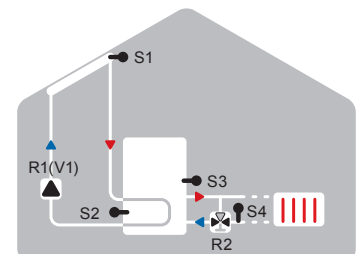

Solar with heating circuit

# Description

## Hydraulic variants

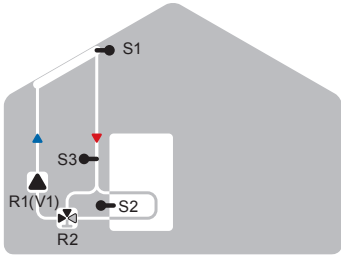

Solar with bypass

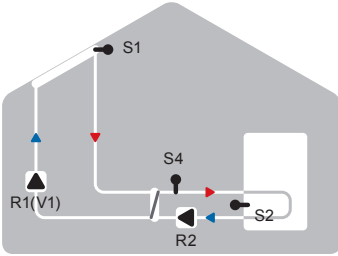

Solar with heat exchanger

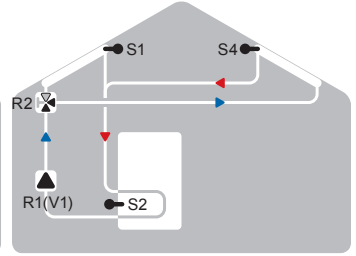

2 East/West solar arrays and 3-way valve

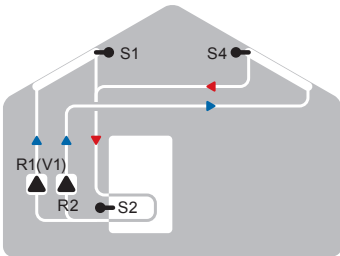

2 East/West solar arrays and 2 pumps

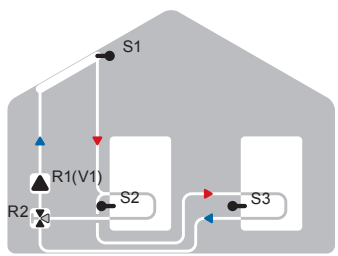

Solar with 2 hot water storage tanks and 3-way valve

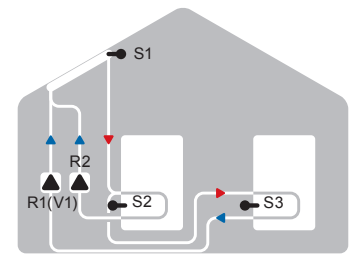

Solar with 2 hot water storage tanks and 2 pumps

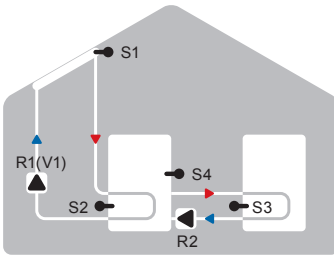

Solar with heat exchange between hot water storage tanks

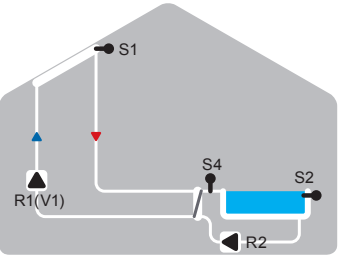

Solar with pool and heat exchanger

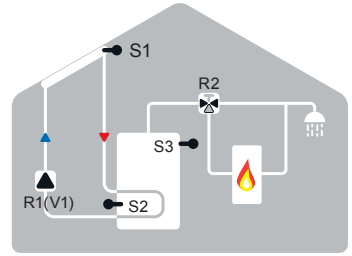

Solar with thermostat and 3-way valve

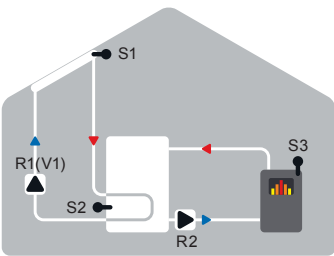

Solar with hot water storage tank and solid fuel boiler

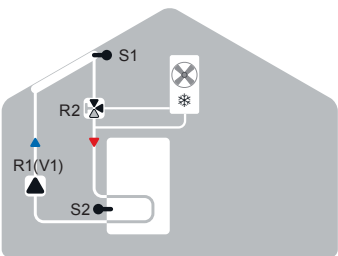

Solar with cooling 1 (collector cooling)

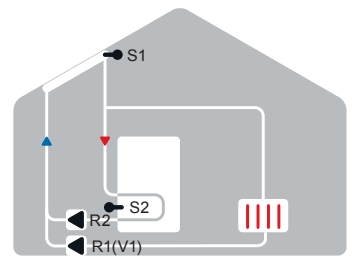

Solar with cooling 2 (collector cooling)

# Description

## Hydraulic variants

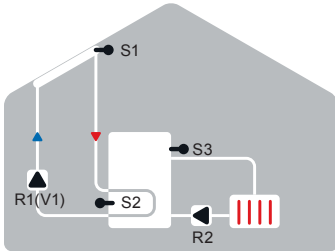

Solar with cooling 3 (collector cooling)

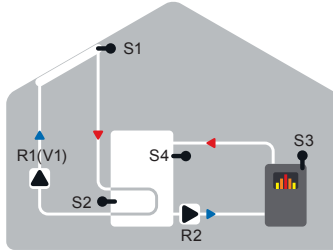

Solar with hot water storage tank and solid fuel boiler and S4

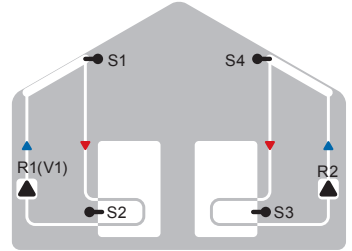

2 East/West solar arrays

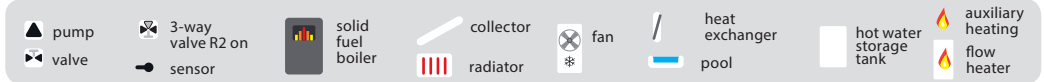





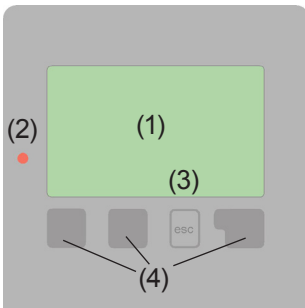





# Operation

## E.1 Display and input



Examples of display symbols:

-  pump (rotates in operation)
-  valve (direction of flow black)
-  collector
-  hot water storage tank
-  swimming pool
-  temperature sensor
-  heat exchanger
-  load pause
-  warning/error message
-  new information available

The display (1) shows graphic and text info on the hydraulic variant, set and measured values and other text info.

LED lamp (2):

**lights up green** - if a relay is closed and the controller works right

**lights up red** - if the controller is set to automatic operation and all relays are open

**flashes slowly red** - if manual operation mode is set

**flashes quickly red** - if an error occurred.

Entries are made using four keys (3+4), which are assigned to different functions depending on the situation.

The "esc" key (3) is used to cancel an entry or to exit a menu.

The function of each of the other three keys (4) is shown in the display line directly above the keys; the right-hand key generally has a selection and confirmation function.

Examples of key functions:

- +/- = increase/decrease values
- ▼/▲ = scroll menu down/up
- YES/NO = approve/reject
- Info = additional information
- Back = to previous screen
- ok = confirm selection
- Confirm = confirm setting

# Operation

## E.2 Commissioning help – Setup wizard

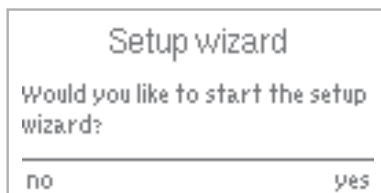

The first time the controller is turned on, language and clock need to be set.

After that a query appears as to whether you want to parameterize the controller using the Setup wizard or not. The Setup wizard can also be terminated or called up again at any time in the special functions menu.

The Setup wizard guides you through the necessary basic settings in the correct order, and provides brief descriptions of each parameter in the display.

Pressing the “esc” key takes you back to the previous value so you can look at the selected setting again

or adjust it if desired. Pressing the “esc” more than once takes you back step by step to the selection mode, thus cancelling the Setup wizard. Finally, menu 3.2 under operating mode “Manual” should be used to test the switch outputs with the solar consumers connected, and to check the sensor values for plausibility. Then switch on automatic mode.

## E.3 Free commissioning

If you decide not to use the commissioning help, you should make the necessary settings in the following sequence:

- Menu 9. Language
- Menu 6.11 Time and date
- Menu 6.1 Program selection
- Menu 4 Settings, all values
- Menu 5 Protective functions if modifications are necessary
- Menu 6 Special functions if additional changes are necessary

*Note:* Setup wizard can be called up any time from the menu 6.8.

Finally, menu 3.2 under operating mode “Manual” should be used to test the switch outputs with the consumers connected, and to check the sensor values for plausibility. Then switch on automatic mode.



Observe the explanations for the individual parameters on the following pages, and check whether further settings are necessary for your application.

# Operation

## E.4 Menu sequence and menu structure

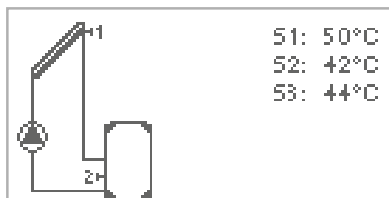

The graphics or overview mode appears when no key has been pressed for 2 minutes, or when the main menu is exited by pressing “esc”.

Pressing any key (4) in graphics or overview mode takes you directly to the main menu. The following menu items are then available for selection there:



1. Measurements	Current temperature values with explanations
2. Statistics	Function control of the system with operating hours etc.
3. Operating mode	Automatic mode, manual mode or switch unit off
4. Settings	Set parameters needed for normal operation
5. Protections	Solar and frost protection, recooling...
6. Special functions	Commissioning help, program selection, sensor calibration, clock etc.
7. Menu lock	Menu lock against unintentional setting changes
8. Service data	Diagnosis in the event of an error
9. Language	Language selection

## Measurements

### 1. - Measurements

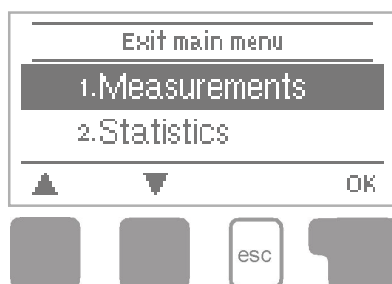

Menu “1. Measurements” serves to display the currently measured temperatures.

What measurement values are displayed depends on the selected program and the specific controller model.

The menu is closed by pressing “esc” or selecting “Exit measurements”.



Caution

If “-” appears on the display instead of the measurement value, then there may be a defective temperature sensor or its wiring. If the cables are too long or the sensors are not placed optimally, the result may be small deviations in the measurement values. In this case the display values can be compensated for using the function of sensor compensation - see Chapter 6.7.

Which sensors are displayed will depend on the program selected, sensors connected and settings.



# Statistics

## 2. - Statistics



Menu “2. Statistics” is used for function control and long-term monitoring of the system.

The menu is closed by pressing “esc” or selecting “Exit statistics”.



Caution

For analysis of the system data it is essential that time is set accurately on the controller. Please note that the clock does not continue to run if the mains voltage is interrupted, and must therefore be reset. Incorrect time set in the controller may result in data being deleted, recorded incorrectly or overwritten.

### 2.1. - Operating hours

Display of operating hours of the solar pump connected to the controller; various time spans are available (last day, week, month, year).

### 2.2. - Heat output

Display of the approximate heat output of the solar thermal system.

### 2.3. - Graphic overview

This provides a clearly-organised display of the data listed under 2.1. - 2.2. as a bar graph. Various time ranges are available for comparison. The two left-hand keys can be used to page through the data.

### 2.4. - Message log

Display of the last 10 events occurring in the system with indication of date and time.

### 2.5. - Reset/clear

Resetting and deleting the individual analyses. The function “All statistics” clears all statistics but not the error messages.

# Operating modes

## 3. - Operating modes



In menu "3. Operating modes" the controller can either be placed in automatic mode, switched off, or placed in a manual operating mode.

The menu is closed by pressing "esc" or selecting "Exit operating modes".

### 3.1. - Automatic

Automatic mode is the normal operating mode of the controller. Only automatic mode provides proper controller function taking into account the current temperatures and the parameters that have been set

### 3.2. - Manual

The relay and thus the connected pump, valve or heating rod are switched on and off manually by pressing a key, with no regard to the current temperatures and the parameters which have been set. The measured temperatures are also shown.



Danger

The manual mode is intended to be used by a technician when commissioning or checking the system. Activating manual mode in current operation can lead to system damage or overheating of water in the hot water storage tank!

### 3.3. - Off



Warning

When the operating mode "Off" is activated, all controller functions are switched off. This can lead, for example, to overheating of the solar collector or other system components. The measured temperatures are displayed even when the controller is Off.

# Settings

## 4. - Settings



The system parameters are set in menu "4. Settings".



Warning

This does not under any circumstances replace the safety elements to be provided by the customer!

The menu is closed by pressing "esc" or selecting "Exit settings".



Caution

Various settings can be made depending on the selection of hydraulic variant 1-27. The following pages contain generally valid descriptions for the settings.

### 4.1. - Tmin S1

#### Sensor S1 switch-on temperature

If this value is exceeded at sensor 1 and the other conditions are also met, then the controller switches the associated pump and/or valve on. If the temperature at sensor 1 drops below this value by 5 °C, then the pump and/or the valve are switched off again.

### 4.3. - Priority Storage 1

#### Priority of Storages

This determines the order in which the storages are charged. If the same priority is set for 2 storages, the charging is not switched over until charging the active storage is not possible anymore.

### 4.4. - $\Delta T1 / \Delta T$ (pool)

#### Switch-on/switch-off temperature difference for solar heat:

If this temperature difference between the reference sensors is exceeded and the other conditions are also met, then the controller switches the applicable relay on. When the temperature drops to  $\Delta T$  Off, then the relay is switched off.



Caution

If the set temperature difference is too small, this may result in ineffective operation, depending on the system and sensor positions. Special switching conditions apply for speed control (see 6.3. - Speed control R1)!

# Settings

## 4.5. - Tmax S2

### Switch-off temperature at sensor S2

If this value is exceeded at sensor 2 and the other conditions are also met, then the controller switches the associated pump and/or valve off. If sensor 2 falls below this value again and the other conditions are also met, then the controller switches the pump and/or valve on again.



Danger

Temperature values which are set high will allow higher solar heat accumulation but it shall be checked that all system components are resistant to high temperatures and scalding protection is provided. Regulus solar thermal systems are safe for heating water up to 95 °C.

## 4.6. - Priority Storage 2

### Priority of Storages S2

This determines the order, in which the storages are charged. If the same priority is set for 2 storages, the charging is not switched over until charging the active storage is not possible anymore.

## 4.7. - $\Delta T2$

Settings see "4.4. -  $\Delta T1$ "

## 4.8. - Tmax S3

Settings see "4.5. - Tmax S2"

## 4.13. - Tmax pool

### Switch-off temperature at pool sensor

If this value is exceeded at the applicable sensor, the controller switches the associated pump and/or valve off. If the temperature falls below this value again and the other conditions are also met, then the controller switches the pump and/or valve on again.



Danger

Temperature values that are set too high can lead to scalding or damage to the system. Scalding protection must be provided by the customer!

# Settings

## 4.14. - Tmax pool HE

### Switch-off temperature at heat exchanger sensor

If this value is exceeded at the applicable sensor, the controller switches the associated pump and/or valve off. If the temperature falls below this value again and the other conditions are also met, then the controller switches the pump and/or valve on again.



Temperature values that are set too high can lead to scalding or damage to the system. Scalding protection must be provided by the customer!

## 4.15. - T priority

**Temperature threshold for absolute priority.** In systems with two storage tanks charging of the lower-priority storage tank will never take place until this temperature at sensor of the higher-priority storage tank is exceeded.

## 4.16. - Loading time

**Interruption of charging into the lower priority storage tank.** The charging of the lower-priority storage tank is interrupted after the settable time in order to check whether the collector has reached a temperature level that allows charging in the higher-priority storage tank. If so, the priority storage tank is charged. If not, the increase is measured, to check if charging of the priority storage tank will be possible shortly.

## 4.17. - Increase

### Extension of the charging pause due to temperature increase in the collector.

For precise setting of the charging priorities for systems with multiple storage tanks, the necessary temperature increase of the collector at which the interruption of the charging into the lower-priority storage tank is extended by one minute is set here. The interruption is extended because the temperature increase of the collector is expected to enable charging in the higher-priority storage tank soon. As soon as  $\Delta T$  conditions are met, the priority storage tank is charged. If the rise in temperature falls below the set value, then the charging of the lower-priority storage tank is enabled again.



Some hydraulic variants (e.g. thermostat,  $\Delta T$ ) may contain additional functions, their settings are described in Chap. 6.5 – Relay functions.

# Protective functions

## 5. - Protective functions



Menu "5. Protections" can be used to activate and set various protective functions.



Warning

This does not under any circumstances replace the safety facilities to be provided by the customer!

The menu is closed by pressing "esc" or selecting "Exit protections".

### 5.1. - System protection

#### Priority protection

Protection of the solar circuit protects its components from overheating. If "**SP T on**" is exceeded at the collector for over 1 minute, the pump is switched off. The collector is left at high temperature. The pump is activated again when the temperature drops below "**SP T off**".



Warning

The collector remains uncooled at a very high temperature. That can lead to shorter service life of solar fluid. If you use this option, take care to check solar fluid quality regularly.

### 5.2. - Collector protection

If „CP Ton" is exceeded at the collector sensor, the pump is switched on in order to cool the collector down. The pump turns off when the collector temperature drops below „CP Toff" or the temperature "**Storage (X) maximum**" is exceeded in the storage or pool. In systems with 2 storage tanks only the lower-priority tank or pool is used for collector cooling.



Danger

When this function is active, a storage tank or swimming pool may get heated up to "Storage (X) maximum", over Tmax S2 (see 4.2. - Tmax S) which might cause damage to the system. When only a pool is heated, it is not used to cool down solar collectors.

# Protective functions

## 5.3. - Recooling

At the end of a sunny day the temperature in a storage tank may easily reach high values. In order to prevent further temperature increase the next day, excess energy can be released into the air via collectors under cloudy conditions or after sunset. If the temperature in the storage tank exceeds the value "**Recool Tsetpoint**" and the collector is at least by 20 °C cooler than the storage tank, the solar pump starts. The storage tank is then cooled down until the "**Recool Tsetpoint**" is reached. In systems with two storage tanks the setting applies to both the storage tanks.



Caution

This function enables to release excess heat from the storage tank considerably and without solar fluid overheating, via piping and collectors into the ambient air. It is recommended to keep activated.

## 5.4. - Frost protection

A two-stage frost protection function is available. In stage 1 the controller switches the pump on for 1 minute every hour if the collector temperature drops below the set value "**Frost level 1**". If the collector temperature drops further to the set value "**Frost level 2**", the controller switches the pump on continuously. If the collector temperature then exceeds the value "**Frost level 2**" by 2 °C, then the pump switches off again.



Caution

This function enables to release excess heat from the storage tank considerably and without solar fluid overheating, via piping and collectors into the ambient air. It is recommended to keep activated.

## 5.5. - Seizing protection

Protection against pump seizing by regular short running of a pump or a valve. Seizing may occur after longer inactivity of valves or pumps. If the seizing protection is activated, the controller switches the relay in question and the connected solar consumer on every day at 12:00 or weekly on Sundays at 12:00 (setting "weekly") for 5 seconds in order to prevent the pump and/or the valve from sticking after an extended stationary period.

## 5.6. - Collector alarm

If this temperature is exceeded at the collector sensor when the solar pump is on, a warning or error message is triggered. A warning message is shown on the display.

# Special functions

## 6. - Special functions



Menu “6. Special functions” is used to set basic items and expanded functions.



Time and Date is the only function to be set by the user. Other functions may be set by a specialist only.

The menu is closed by pressing “esc” or selecting “Exit special functions”.

### 6.1. - Program selection

The suitable hydraulic variant for the specific application is selected and set here (see Chap. D.1 Hydraulic variant). The associated diagram is displayed on pressing “info”.



Caution

Normally the program selection is made only once during initial commissioning by the specialist. Incorrect program selection can lead to unpredictable errors.



Caution

If the program is changed, the settings revert to factory settings.

### 6.2. - Pump settings V1

This menu contains the settings for the speed controlled output V1.

#### 6.2.1. - Type of signal

The type of speed controlled pump must be entered here.

**0-10V:** Speed control of a high efficiency pump by 0-10V signal.

**PWM:** Speed control of a high efficiency pump by PWM signal.



Caution

For control of standard pumps, no settings are needed in this menu. Just connect the pump’s power supply cable to R1.

#### 6.2.2. - Pump profile

Selection from preset pump control profiles. The setting can be done manually as well. Parameters may be changed manually even when a preset profile is set.



## Special functions

### 6.2.3. - Output Signal

This menu determines the type of pump used: Solar pumps perform at their highest power when the signal is also at its maximum, heating pump on the other hand are set to highest power when the control signal is at its minimum. Solar = normal, heating = Inverted.

### 6.2.4. - 0-10V / PWM off

This signal is put out when the pump is switched off (pumps that can detect cable break need a minimum voltage).

### 6.2.5. - 0-10V / PWM on

This signal is needed to turn the pump on at minimum speed.

### 6.2.6. - 0-10V / PWM max

This determines the output voltage for the maximum performance of the pump that is used e.g. during purging or manual operation.

### 6.2.7. - Show signal

Displays the set signal in text and a graphical diagram.

# Special functions

## 6.3. - Speed control

With speed control the SRS3 E makes it possible to vary the speed of connected pumps.



This function should only be activated by a specialist. Depending on the pump and pump stage used, the minimum speed should not be set too low, because otherwise the pump or the system may be damaged. The information provided by the relevant manufacturer must also be observed! If in doubt, the min. speed and the pump stage should generally be set to high rather than too low.

### 6.3.1. - Modes

The following speed variants are available here:

**Off:** There is no speed control. The connected pump is only switched on or off with full speed.

**M1:** Control set to  $\Delta T$ , starting from max. speed:

After the purging time the controller switches to the set max. speed. If the temperature difference  $\Delta T$  between the reference sensors (collector and storage tank) is less than the set value, then the speed is decreased by one stage after the Sweep time elapses. If the temperature difference between the reference sensors is greater than the set value, then the speed is increased by one stage after the Sweep time elapses. If the controller has adjusted the speed of the pump down to the smallest stage and the  $\Delta T$  between the reference sensors is less than  $\Delta T$  off, the pump is switched off.

**M2:** Control set to  $\Delta T$ , starting from min. speed:

After the purging time the controller switches to the set min. speed. If the temperature difference  $\Delta T$  between the reference sensors (collector and storage tank) is greater than the set value, then the speed is increased by one stage after the Sweep time elapses. If the temperature difference between the reference sensors is less than the set value, then the speed is decreased by one stage after the Sweep time elapses. If the controller has adjusted the speed of the pump down to the smallest stage and the  $\Delta T$  between the reference sensors is below  $T\Delta$ off, the pump is switched off.

**M3:** Control to constant collector temperature, starting from min. speed:

The pump starts at max. speed. After the purging time the controller switches to the set min. speed. If the temperature at the collector sensor (or relay R2 in variants with a heat exchanger) is greater than the Setpoint, then the speed is increased. If the temperature at the collector sensor is less than the Setpoint, then the speed is decreased.

**M4:** If the storage tank of the highest priority is heated to the desired temperature, then the speed control works by variant M3. If the (secondary) storage tank of a lower priority is heated to the desired temperature, then the speed control works by variant M2.

## Special functions

### 6.3.2. - Purging time

During this time the pump runs at its full speed (100 %) to ensure reliable starting. Only after this purging time does the pump run with speed control and switches to the max. or min. speed, depending on the variant set (M1-M4). Purging is not used for PWM/ 0-10V output.

### 6.3.3. - Sweep time

In the process of speed control a certain delay before any speed change is needed in order to avoid quick speed changes and subsequent large temperature oscillations. The meaning of the parameter is described above.

### 6.3.4. - Max. speed

The maximum speed of the pump is specified here. During the setting the pump runs at the specified speed and the flow rate can be determined.



Caution

The indicated percentages are guide values that may vary to a greater or lesser extent depending on the system, pump and pump stage.

### 6.3.5. - Min. speed

The minimum speed of the pump at relay R1 is specified here.



Caution

The minimum speed of the pump at relay R1 is specified here. The indicated percentages are guide values that may vary to a greater or lesser extent depending on the system, pump and pump stage. 100% is the maximum possible voltage/frequency of the controller.

### 6.3.6. - Setpoint

This value is the control setpoint for variant M3 (see Chap. 6.3.1). If the value at the collector sensor drops below the Setpoint, the speed is reduced. If it rises above the Setpoint, the speed is increased.

### 6.3.7. - Set $\Delta T$

This value is the selectable temperature difference for modes M1 and M2 (see 6.3.1 - Modes). Below this  $\Delta T$  value between the reference sensors, the speed is reduced. When above this value, the speed is increased.

# Special functions

## 6.5. - Relay functions

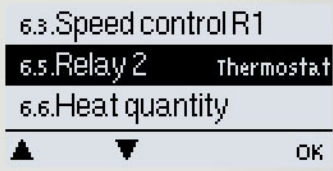

The here explained additional functions can be assigned to unused relays. Every additional function can only be used once. Pay special attention to the technical data of the relays („B.1. - Specification“).

Example

Solar +

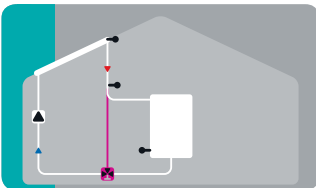

Solar with storage and additional Solar Bypass function

Solar +

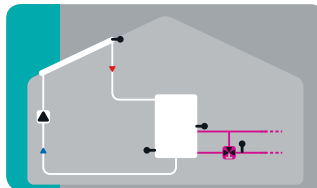

Solar with heat exchanger and additional Return Flow Increase function

Solar +

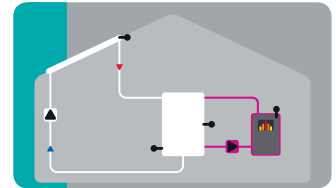

Solar with heat exchanger and additional Solid Fuel Boiler function



Numbering does not have to correspond to the numbering in the controller menu.



### 6.5.1. - Solar bypass

**Use the relay to switch a bypass valve or a bypass pump.**

This can direct the flow pass the storage, when the flow temperature at the bypass sensor is lower than the storage that has to be charged.

#### 6.5.1.2. - Variant

This menu determines whether a pump or valve is used to direct the flow through the bypass.

#### 6.5.1.3. - Bypass (sensor)

The flow sensor for the bypass function is selected in this menu. Do not install in the return line.

# Special functions



## 6.5.2. - Thermostat

Thermostat is used for time- and temperature controlled auxiliary heating.



Temperature values which are set too high can lead to scalding or damage to the system. Scalding protection must be provided by the customer!



In Energy savings mode, different settings may apply, see e.g. T eco.

### 6.5.2.2. - Target temperature (TH TSet)

Target temperature at thermostat sensor 1. Below this temperature, auxiliary heating is switched on, until TH set + hysteresis is reached.

### 6.5.2.3. - Hystereze (Term. hyster.)

Hysteresis (TH hysteresis)

### 6.5.2.4. - Thermostat (sensor)

T set is measured with thermostat sensor 1.

When thermostat sensor 2 is connected, the relay switches on when T set is not reached at thermostat Sensor 1, and switches off when T set + hysteresis at thermostat sensor 2 is exceeded.

### 6.5.2.5. - Thermostat 2 (sensor)

#### Optional switch off sensor

When T set + hysteresis is exceeded at the optional thermostat sensor 2, the relay is switched off.

### 6.5.2.6. - T eco

For Energy saving mode

When Energy saving mode is active: During solar charge T eco is used instead of TH set. When the temperature drops below T eco at thermostat sensor 1, the relay is switched on and heats up to T eco + hysteresis.

### 6.5.2.7. - Storage

For Energy saving mode

Loading this storage activates the Energy saving mode When this storage is charge by solar, additional heating is only switched on when the temperature is below T eco.

# Special functions

## 6.5.2.8. - Energy saving mode

Energy saving mode switches the heating on when T eco is not reached and heats up to T eco + hysteresis when solar charge is active.

## 6.5.2.9. - Periods

### Thermostat activity times

Set the desired periods of time when the thermostat should be active. 3 periods can be set per day, settings can also be copied to other days. Outside the set times the thermostat is switched off.



## 6.5.3. - Cooling

This is used to cool down e.g. storages to a setpoint temperature by radiating heat.

### 6.5.3.2. - Desired temperature (Co T set)

Target temperature at the cooling sensor. Cooling is on above this temperature till Co T set + hysteresis is reached.

### 6.5.3.3. - Co hysteresis

If the temperature at the cooling sensor drops below Co T set + hysteresis, the relay is switched off.

### 6.5.3.4. - Cooling (sensor)

Reference sensor of the cooling function.

### 6.5.3.5. - Periods

#### Cooling activity times

Set the desired periods of time when the cooling should be active. 3 periods can be set per day, settings can also be copied to other days. Outside the set times the cooling function is switched off.



## 6.5.4. - Return flow increase

This function is used to increase the temperature of e.g. the return flow by the storage.

### 6.5.4.2. - Return flow max. temperature (RF Tmax)

Maximum temperature at the return flow sensor. If this temperature is exceeded, the relay is switched off.

# Special functions

## 6.5.4.3. - $\Delta T$ return flow

Switch-on temperature difference:

When this difference is exceeded between return flow sensor and storage sensor, the relay is switched on.

Switch-off temperature difference:

When this difference is exceeded between return flow sensor and storage sensor, the relay is switched off.

## 6.5.4.4. - Return flow (sensor)

Determines the sensor for return flow increase.

## 6.5.4.5. - Storage (sensor)

Determines the storage sensor.



## 6.5.5. - Collector cooling

This function controls an external cooling unit to cool down the collector.

### 6.5.5.2. - Max. temperature (Tmax coll.)

If this temperature is exceeded at the reference sensor, the relay is switched on.

### 6.5.5.3. - Switch off difference (Hys min)

When the temperature falls below Tmax coll. + Hys min, the relay is switched off.

### 6.5.5.4. - Max. difference (Hys max)

To protect the cooling unit itself from damage, the relay is switched off as soon as the temperature at the reference sensor reaches Tmax coll. + Hys max

### 6.5.5.5. - Collector cooling sensor

Reference sensor of the collector cooling function.



This function does not activate the solar pump to cool the collector. Therefore, please refer to the collector protection.

# Special functions



## 6.5.6. - Anti Legionella

This function is used to heat up the system during selected periods to eliminate legionella bacteria.

### 6.5.6.2. - Anti Legionella set temperature (AL T set)

This temperature has to be detected for the time set in AL residence time at the AL sensors for a successful heat up.

### 6.5.6.3. - AL residence time

This determines the time span for which the AL T set temperature must be detected for a successful AL heat up.

### 6.5.6.4. - Last AL heat

This displays the date and time of the last successful heat up.

### 6.5.6.5. - AL sensor 1

This temperature is used to measure the AL temperature.

### 6.5.6.6. - AL sensor 2

#### Optional AL sensor

When a second sensor is connected, both sensors must reach and hold the set-point temperature for the residence time for a successful heat up.

### 6.5.6.7. - AL-times

During this periods the AL heat up is attempted.



Warning

This anti-Legionella function does not provide complete protection against Legionella, because the controller is dependent on sufficient energy being fed in, and it is not possible to monitor the temperatures in the entire range of the storage tanks and the connected piping system. To provide complete protection against Legionella bacteria, it must be ensured that the temperature is raised to the necessary temperature, and at the same time there must be water circulation in the storage tank and piping system by means of other additional energy sources and external control units.



Caution

The anti-Legionella function is switched off at delivery. Whenever heating-up has been carried out with the anti-Legionella function switched on, an information message with the date appears on the display.



Danger

During the anti-Legionella function the storage tank is heated up over the set value "Tmax S(X)", which can lead to scalding and damage to the system.





## 6.5.7. - Heat transfer

This is used to transfer energy from one storage to another with a pump.

### 6.5.7.2. - Min. temperature (Shift Tmin)

Minimum temperature in source storage to enable the heat transfer.

### 6.5.7.3. - Temperature difference for heat transfer ( $\Delta T$ Heat transfer)

#### Temperature difference for heat transfer function.

When the temperature difference between HT Source and HT Drain reaches  $\Delta T$  Heat Transfer On, the relay is switched on. As soon as the difference drops to  $\Delta T$  Heat Transfer Off, the relay is switched off again.

### 6.5.7.4. - Setpoint (Př.tep. Tnast.)

#### Setpoint temperature of the target storage

When this temperature is detected in the target storage, heat transfer is switched off.

### 6.5.7.5. - HT Source (sensor)

This menu determines the sensor placed in the source storage.

### 6.5.7.6. - HT Drain (Target sensor)

This determines the sensor placed in the storage that is receiving energy from the source storage.



## 6.5.8. - Difference

The relay is switched on when a specific temperature difference ( $\Delta T$ ) is reached.

### 6.5.8.2. - Diff Tmin

**Minimum temperature at source sensor to enable the difference relay.**

When the temperature at the source sensor is below this level, the difference function is disabled.

### 6.5.8.3. - $\Delta T$ difference

**Switch-on difference:**

When this temperature difference is reached, the relay is switched on.

**Switch-off difference:**

When the temperature difference drops below this value, the relay is switched off.

### 6.5.8.4. - DF Tmax

**Maximum temperature at target sensor to enable difference function**

If the temperature at the target sensor exceeds this value, difference function is disabled.

### 6.5.8.5. - DF source (sensor)

**Heat source sensor for Difference function.**

This determines the sensor for the heat source.

### 6.5.8.6. - DF Drain (sensor)

**Drain sensor / Target sensor for difference function**

This determines the sensor for the target storage.

## Special functions



### 6.5.9. - Solid fuel boiler

The relay is used to control an additional solid fuel boiler.

#### 6.5.9.2. - Min. solid fuel boiler temperature (SF Tmin)

Minimum temperature in the solid fuel boiler to switch on the pump. If the temperature at the boiler sensor is below this temperature, the relay is disabled.

#### 6.5.9.3. - Temper. difference for solid fuel boiler ( $\Delta T$ Solid fuel)

Switch on and Switch off condition for the temperature difference between boiler and storage. Switch on difference  $\Delta T$  SF. Switch off temperature difference  $\Delta T$  SFOff.

#### 6.5.9.4. - Max. storage temperature (SF Tmax)

Maximum temperature in the storage. If this is exceeded, the relay is switched off.

#### 6.5.9.5. - Boiler sensor

This determines the sensor used as boiler sensor.

#### 6.5.9.6. - Storage sensor

This determines the sensor that is used as storage sensor.



### 6.5.10. - Error message

The relay is switched on when one or more protective functions are active. This function can be inverted, so that the relay is always on and switches off when a protective function is shown.

**Collector protection, System protection, Frost protection, Recooling, Anti-legionella protection, Messages, Collector alarm**



### 6.5.11. - Booster pump

Additional pump that fills the system at the start of every solar charge.

#### 6.5.11.2. - Filling time

##### Time the pump is switched on

This setting determines the length of time the pump is switched on at the start of a solar charge.

## Special functions

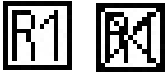

### 6.5.12. - SParallel operation R (X)

The relay is switched on at the same time as the set relay R1 or R2.

#### 6.5.12.2. - Delay

This menu determines how long after the start of R1 or R2 the parallel relay is switched on.

#### 6.5.12.3. - Followup time

This menu determines how long after the switch off of R1 or R2 the parallel relay is switched off.



### 6.5.13. - Always on

Relay is always switched on.

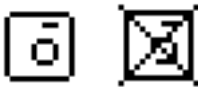

### 6.5.14. - Heating circuit

Heat circuit pump is controlled with a fixed hysteresis of (+/-1 °C for setpoint temperature). 30 seconds Switch on and Switch off delay is fixed setting to prevent unnecessary switching of the pump. RC21 room controller can be used as room temperature sensor.

#### 6.5.14.2. - Desired temperature - day (Room set day)

Room reference temperature in day mode. If this temperature is exceeded at the room temperature sensor at the set times, the relay is switched off.

#### 6.5.14.3. - Desired temperature - night (Room set night)

Room reference temperature in night mode. If this temperature is exceeded at the room temperature sensor at the set times, the relay is switched off.

#### 6.5.14.4. - Room sensor

This menu determines the sensor for the room temperature.

#### 6.5.14.5. - Periods

Set the desired periods of time when the heat circuit day mode should be active. 3 periods can be set per day, settings can also be copied to other days. Outside the set times the heating function is working in night mode.

# Special functions

## 6.6. - Heat quantity

### 6.6.1. - Flow rate

When the heat meter mode „Flow rate“ is selected, an approximate heat quantity is calculated using the values the user has to enter. These are type of glycol/AntiFreeze, glycol portion and flow rate. These values are put into correlation with the temperature data of collector sensor and storage sensor. If necessary a correction value for  $\Delta T$  can be set: Since for the heat meter the collector and the storage temperature are used, a difference to the flow respectively return flow temperature can be compensated by changing Offset  $\Delta T$  accordingly.

#### **Example:**

*Displayed collector temp. 40 °C, measured flow temperature 39 °C, displayed storage temperature 30 °C, measured return temperature 31 °C = results in a correction value of -20% (displayed  $\Delta T$  10 K, real  $\Delta T$  8 K = -20 % correction)*



The heat quantity measured in the mode “Flow rate” is a calculated approximation for function control of the system.

### 6.6.2. - Flow sensor

This determines the sensor that is used to measure the flow temperature.

### 6.6.3. - Return sensor

This determines the sensor that is used to measure the return temperature.

### 6.6.4. - Antifreeze type

Set the type of antifreeze used. If none is used, please set to 0.

### 6.6.5. - Glycole percentage

The amount of antifreeze agent in the system.

### 6.6.6. - Flow rate

#### **Flow rate that is used to calculate the heat quantity**

This determines the flow rate in litres per minute that is used for the calculation of the heat quantity.

### 6.6.7. - Offset $\Delta T$

#### **Correction value for temperature difference**

Since for the heat meter the collector and the storage temperature are used, a difference to the flow respectively return flow temperature can be compensated by changing Offset  $\Delta T$  accordingly.

#### **Example:**

*Displayed collector temp. 40 °C, measured flow temperature 39 °C, displayed storage temperature 30 °C, measured return temperature 31 °C = results in a correction value of -20 % (displayed  $\Delta T$  10 K, real  $\Delta T$  8 K = -20 % correction).*

# Special functions

## 6.7. - Sensor calibration

Deviations in the temperature values displayed, for example due to cables which are too long or sensors which are not positioned optimally, can be compensated for manually here. The settings can be made for each individual sensor in steps of 0.8 °C (temperature) resp. 0.2 % of the measuring range of the VFS / RPS sensor (flow rate / pressure) per step.



Caution

Settings are only necessary in special cases at the time of initial commissioning by the specialist. Incorrect measurement values can lead to unpredictable errors.

## 6.8. - Commissioning

Starting the commissioning help guides you in the correct order through the basic settings necessary for commissioning, and provides brief descriptions of each parameter in the display. Pressing the “esc” key takes you back to the previous value so you can look at the selected setting again or adjust it if desired. Pressing the “esc” more than once takes you back to the selection mode, thus cancelling the commissioning help (see also E.2)..



Caution

May only be started by a specialist during commissioning! Observe the explanations for the individual parameters in these instructions, and check whether further settings are necessary for your application.

## 6.9. - Factory settings

All of the settings that have been made can be reset, thus returning the controller to its delivery state.



Caution

The entire parametrisation, analyses, etc. of the controller will be lost irrevocably. The controller must then be commissioned once again.

## 6.10. - Start aid function

With some solar systems, especially with evacuated tube collectors, it may occur that the measurement value acquisition at the collector sensor occurs too slowly or too inaccurately because the sensor is often not at the hottest location. When the start help is activated the following sequence is carried out: If the temperature at the collector sensor increases by the value specified under “Increase” within one minute, then the solar pump is switched on for the set “Purging time” so that the medium to be measured can be moved to the collector sensor. If this still does not result in a normal switch-on condition, then the start help function is subject to a 5-minute lockout time.



Caution

This function should only be activated by a specialist if problems arise with acquisition of measurement values. In particular follow the instructions from the collector manufacturer.

# Special functions

## 6.11. - Time and date

This menu is used to set the current time and date.



Caution

For analysis of the system data it is essential for the time to be set accurately on the controller. Please note that the clock does not continue to run if the mains voltage is interrupted, and must therefore be reset.

## 6.12. - Daylight saving time

When this function is active, the controller's clock changes automatically to and from DST (Daylight Saving Time).

## 6.13. - Eco display mode

When active, the display backlight is switched off after 2 minutes of inactivity.



Caution

If a message is waiting, the backlight is not switched off.

## 6.14. - Temperature unit

This menu is used to select the temperature unit that is displayed.

## 6.15. - Network

In this menu, the settings of the ethernet connection of the datalogger are set.

### 6.15.1. - Access Control

In this menu you can add or remove four users who should have access to the datalogger. To add a user in the list, select <add user>. The list shows you the last 5 users that tried to connect to the datalogger. Select a user with OK to grant him access. To revoke access again choose one of the 4 users from your list and choose <remove user>.

### 6.15.2. - Ethernet

In this menu, the settings of the ethernet connection of the datalogger can be set.

#### 6.15.2.1. - Ethernet

Activate or deactivate the ethernet function.

#### 6.15.2.2. - MAC Adress

Displays the individual MAC address of the datalogger.

#### 6.15.2.3. - Auto-Configuration (DHCP)

If activated, the datalogger requests IP addresses and network parameters from a DHCP server.

#### 6.15.2.4. - IP Address

In this menu, the IP address of the datalogger can be set.

#### 6.15.2.5. - Subnet

In this menu the subnet mask of the datalogger can be set.

#### 6.15.2.6. - Gateway

In this menu, the IP of the gateway for the datalogger can be set.

#### 6.15.2.7. - DNS Server

In this menu, the IP address of the DNS server can be set.

# Menu lock

## 7. - Menu lock

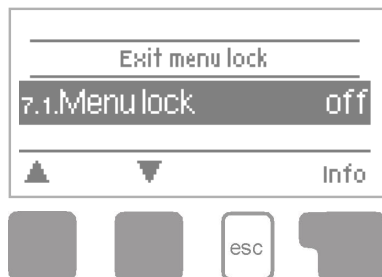

Menu “7. Menu lock” can be used to secure the controller against unintentional changing of the set values.

The menu is closed by pressing “esc” or selecting “Exit menu lock”.

The menus listed below remain completely accessible despite the menu lock being activated, and can be used to make adjustments if necessary:

1. Measurements
2. Statistics
3. Operating modes
- 6.11 Time and Date
7. Menu lock
8. Service values

To lock the other menus, select “Menu lock on”. To enable the menus again, select “Menu lock off”.



# Service values

## 8. - Service values

The menu “8. Service values” can be used for remote diagnosis by a specialist or the manufacturer in the event of an error, etc.



Caution

Enter the values at the time when the error occurred e.g. in the table.

The menu can be closed at any time by pressing “esc”.

8.1	
8.2	
8.3	
8.4	
8.5	
8.6	
8.7	
8.8	
8.9	
8.10	
8.11	
8.12	
8.13	
8.14	
8.15	
8.16	
8.17	
8.18	
8.19	
8.20	
8.21	
8.22	
8.23	
8.24	
8.25	
8.26	
8.27	
8.28	
8.29	
8.30	

8.31	
8.32	
8.33	
8.34	
8.35	
8.36	
8.37	
8.38	
8.39	
8.40	
8.41	
8.42	
8.43	
8.44	
8.45	
8.46	
8.47	
8.48	
8.49	
8.50	
8.51	
8.52	
8.53	
8.54	
8.55	
8.56	
8.57	
8.58	
8.59	
8.60	

# Language

## 9. - Language

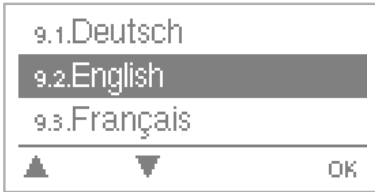

Menu “9. Language” can be used to select the language for the menu guidance. This is queried automatically during initial commissioning.



# Malfunctions, additional info

## Z.1. Malfunctions with error messages

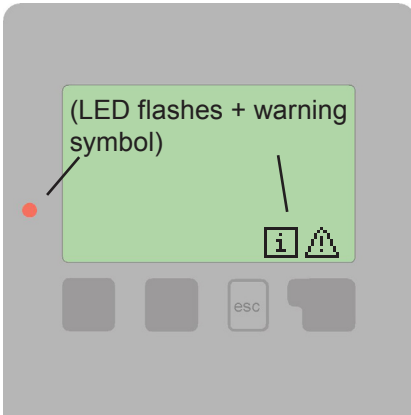

If the controller detects a malfunction, the red light flashes and the warning symbol also appears in the display. If the error is no longer present, the warning symbol changes to an info symbol and the red light no longer flashes.

To obtain more detailed information on the error, press the key under the warning or info symbol.



Do not try to deal with this yourself. Consult a specialist in the event of an error!

Possible error messages:	Notes for the specialist:
Sensor x defective	Means that either the sensor, the sensor input at the controller or the connecting cable is/was defective. (Resistance table see Chap. B.2)
Collector alarm	Means that the collector temperature has exceeded the temperature set under menu 5.6
Restart	Means that the controller was restarted, for example due to a power failure. Check the date&time!
Time & Date	This message appears automatically after a mains failure because the time & date have to be checked, and reset if necessary.
No flow!	This is displayed when $\Delta T$ between storage and collector is $50\text{ }^{\circ}\text{C}$ or higher for 5 minutes without interruption.
Frequent on / off	A relay was switched on and off more than 5 times within 5 minutes.
AL failed	This is displayed when AL ref $-5\text{ }^{\circ}\text{C}$ was not measured for the set AI residence time at the AL sensor.

# Malfunctions, additional info

## Z.2 Replacing the fuse



Repairs and maintenance may only be performed by a specialist. Before working on the unit, switch off the power supply and secure it against being switched on again! Check for the absence of power!



Only use the supplied spare fuse or a fuse of the same design with the following specifications: T2A 250V.

### Z.2.1

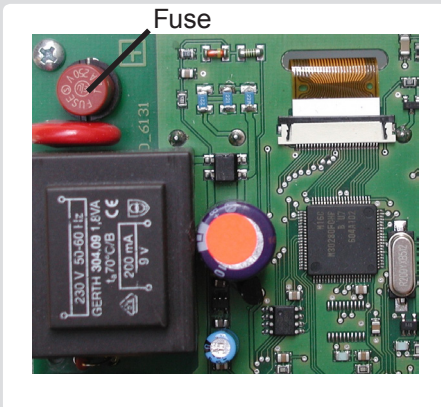

If the mains voltage is switched on and the controller still does not function or display anything, then the internal device fuse may be defective. In that case, disconnect the device, open it, remove the old fuse and check it. If it is defective, replace it with a new one, locate the external source of the error (e.g. pump) and replace it. Then first re-commission the controller and check the function of the switch outputs in manual mode as described in Chap. 3.2.

## Z.3 Maintenance



Caution

In the course of the general annual maintenance of your heating system you should also have the functions of the controller checked by a specialist and have the settings optimised if necessary.

Performing maintenance:

- Assess/check plausibility of analyses (see Chap. 6.11)
- Assess/check plausibility of analyses (see Chap. 2)
- Check the error log (see Chap. 2.4.)
- Verify/check plausibility of the current measurement values (see Chap. 1)
- Check the switch outputs/consumers in manual mode (see Chap. 3.2)
- Possibly optimise the parameter settings

# Malfunctions, additional info

## Z.4 CAN Bus

The CAN bus can be used to connect two or more controllers with each other or with the datalogger to exchange data.

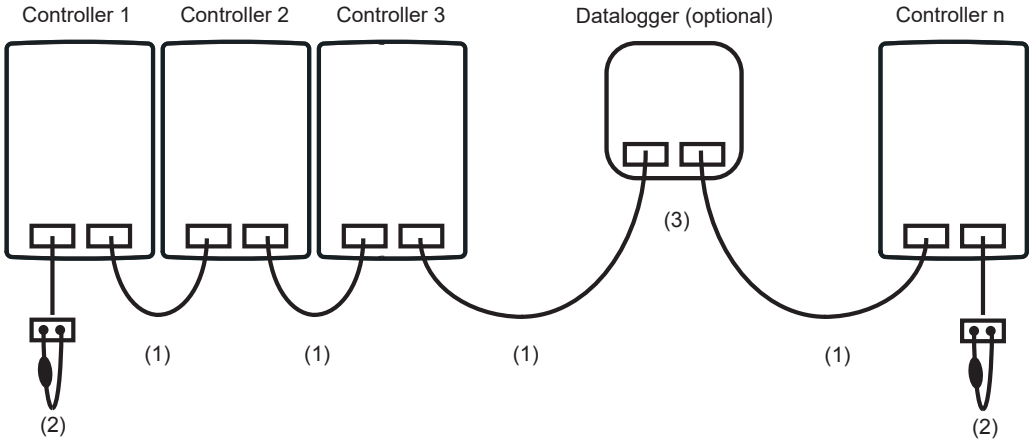

1. The controllers are connected in series with the CAN bus cable (1).
2. The first and last controller/data logger in this connection series must be fitted with a terminating resistor (2).

**The wiring of the two CAN sockets is optional.**

3. Optionally, the data logger (3) can be integrated in a CAN bus.

The available CAN functions are subject to the controller type as well as the software version used and can be seen in the corresponding manual.

## Tips & Tricks

Instead of setting the flow rate for the system using a flow rate limiter, it is better to adjust the flow rate using the switch on the pump and by means of the “max. speed” setting on the controller (see 6.3.4). This saves electricity!

The service values (see 8.) include not only current measurement values and operating states, but also all of the settings for the controller. Write the service values down just after commissioning has been successfully completed.

In the event of uncertainty as to the control response or malfunctions the service values are a proven and successful method for remote diagnosis. Write the service values down (see 8.) at the time that the suspected malfunction occurs. Send the service value table by fax or e-mail with a brief description of the error to a specialist.

In the hydraulic variant with pool the charging of the pool, e.g. for winter operation, can be switched off using a simple function. To do this, simply press and hold the “esc” key down for several seconds on the diagram/overview screen. A message appears on the display as soon as the pool is switched off or when the pool is switched on again.

The Operating hours displayed in the “Statistics” menu are solar operating hours. This therefore only takes into account hours in which the solar pump is active. In the universal programs the times refer to relay R1.

It is recommended to record any statistics and data that are particularly important to you at regular intervals.



**REGULUS spol. s r.o.**  
Do Koutů 1897/3  
143 00 Praha 4

<http://www.regulus.eu>  
E-mail: [sales@regulus.eu](mailto:sales@regulus.eu)