

Installation, wiring and operating instructions

TRS 5 Controller

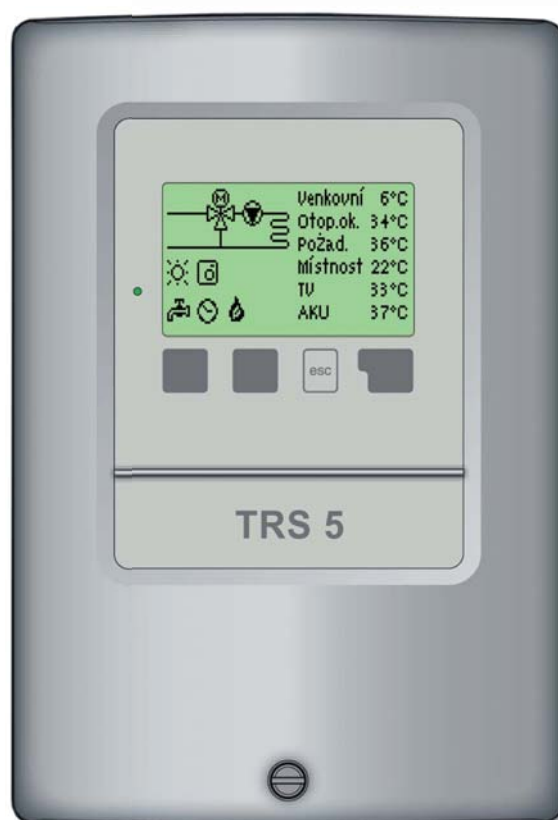

CE

EN
v 1.1

Regulus

EC Declaration of Conformity

By affixing the CE mark to the unit the manufacturer declares that the **TRS5** conforms to the following relevant safety regulations:

- Directive 2006/95/EC - EC low voltage directive (LVD)
- Directive 2004/108/EC - EC electromagnetic compatibility directive (EMC)

General instructions - it is essential to read this!

These installation and operating instructions contain basic instructions and important information regarding safety, installation, commissioning, maintenance and the optimal use of the unit.

Therefore these instructions must be read completely and understood by the installation technician/specialist and by the system user.

Installation shall be done according to valid standards and rules. The controller does not under any circumstances replace any safety devices to be provided by the customer (e.g. a safety valve, air vent valve etc.)!

The installation shall be done by a qualified specialist who is trained accordingly.

For the user:

Make sure that the specialist gives you detailed information on the function and operation of the controller. Always keep these instructions in the vicinity of the controller.

Changes to the unit



Changes to the unit can compromise the safety and function of the unit or the entire solar system!

- Changes, additions to or conversion of the unit are not permitted without written permission from the manufacturer.
- It is forbidden to install additional components that have not been tested together with the unit.
- The controller must not be used after an accident when its functions could have been altered - e.g. after a fire. It must be turned off immediately.
- Use only original spare parts.
- Marking of the manufacturer and distributor must not be altered or removed.
- Only the settings actually described in these instructions may be made on the controller.

CONTENTS

A - Description and Installation	
A 1 - Specification	4
A 2 - Description	5
A 3 - Scope of supply	5
A 4 - Explanation of symbols in texts	5
B - Hydraulic variants	
C - Installation	
C 1 - Wall installation	7
C 2 - Electric wiring	8
C 3 - Installing the temperature sensors	8
D - Electric Wiring of Hydraulic Variants	
E - Controller Use	
E 1 - Display and input	10
E 2 - Menu sequence and menu structure	11
E 3 - Commissioning help - setup wizard	12
E 4 - Free commissioning	12
F - Parameter Setting	
F 1 - Measurements	13
F 2 - Statistics	14
F 3 - Times	15
F 4 - Operating modes	16
F 5 - Settings HC	17
F 6 - Settings DHW	19
F 7 - Protective functions	20
F 8 - Special functions	21
F 9 - Menu lock	23
F 10 - Service values	24
F 11 - Language	25
G - Defects and Maintenance	
G 1 - Error and info messages	26
G 2 - Replacing the fuse	27
G 3 - Maintenance	27
G 4 - Useful hints and tricks	28
G 5 - Disposal	28

A - DESCRIPTION AND INSTALLATION

A 1 - Specification

Electric specification:

Mains voltage	230 V ~ ±10 %
Mains frequency	50-60Hz
Power consumption	2 VA
Total switched power	460 VA (relay outputs 1-3)
Switched power per relay	460 VA for AC1 / 185W for AC3
Internal fuse	2 A slow-blow, 250 V
El. protection	IP40
Protection class	II
Sensor inputs	5× Pt1000 1× remote controller
Measuring range	-40 to 110 °C

Permissible ambient conditions:

Ambient temperature

- for controller operation	0-40 °C
- for transport/storage	0-60 °C

Air humidity

- for controller operation	max. 85 % rel. humidity at 25 °C
- for transport/storage	no moisture condensation permitted

Other specifications and dimensions:

Housing design	2-part, ABS plastic
Installation method	wall installation
Overall dimensions	163 × 110 × 52 mm
Aperture installation dimensions	157 × 106 × 31 mm
Display	fully graphical display, 128 × 64 bodů
Operation	4 entry keys

Optional temperature sensors:

Immersion sensor	Pt1000, with lead TT/P4 up to 95 °C
Pipe-mounted sensor	Pt1000, pipe-mounted TR/P4 up to 95 °C
Outdoor temperature sensor	Pt1000, type TA52
Remote controller	Pt1000, type RC21
Sensor leads	2× 0.75 mm ² extendable up to 30 m

Temperature resistance table for Pt1000 sensors:

°C	0	10	20	30	40	50	60	70	80	90	100
Ω	1000	1039	1077	1116	1155	1194	1232	1270	1308	1347	1385

A 2 - About the controller

The weather controlled Heating Controller TRS 5 facilitates efficient use and function control of your heating system. This type is designed to control **one mixed heating circuit** and **domestic hot water (DHW) heating**. It is equipped with 5 connection outputs for e.g. two pumps and one mixing valve and one heat source (boiler). The TRS 5 has 6 connection inputs for heat sensors and a remote controller. For each step in the input process the individual entry keys are assigned to appropriate functions and explained. The controller menu contains headwords for the measured values and settings, as well as help texts or clearly-structured graphics.

Important properties of TRS 5:

- both graphics and texts on a backlit display
- simple viewing of the current measurement values
- analysis and monitoring of the system also by means of statistical graphics
- extensive menus with interactive explanations
- menu lock can be activated to prevent unintentional setting changes
- usual preset parameters in factory setting

A 3 - Scope of supply

- TRS5 heating controller
- 3 screws 3.5 × 35 mm and 3 plugs 6mm for wall installation
- 6 strain relief clips with 12 screws
- Replacement fuse 2A slow-blow, 250 V
- Installation, wiring and operating instructions
- 2× pocket-mounted temperature probe Pt1000, with lead TT/P4 up to 95 °C
- 1× pipe-mounted sensor Pt1000, pipe-mounted TR/P4 up to 95 °C
- 1× outdoor sensor Pt1000, type TA52

A 4 - Explanation of symbols



Danger

Failure to observe these instructions can result in danger to life from electric voltage.



Danger

Failure to observe these instructions can result in serious damage to health such as scalding, or even life-threatening injuries.



Danger

Failure to observe these instructions can result in destruction of the unit or the system, or damage to the environment.



Caution

Information which is especially important for the function and optimal use of the unit and the system.

B - HYDRAULIC VARIANTS

The following illustrations should be viewed only as schematic diagrams showing the respective hydraulic systems, and do not claim to be complete. The controller does not replace safety device under any circumstances. Depending on the specific application, additional system components and safety components may be mandatory, such as check valves, non-return valves, safety temperature limiters, scalding protectors, etc., and must therefore be provided.

1. Mixed heating circuit with accumulation tank

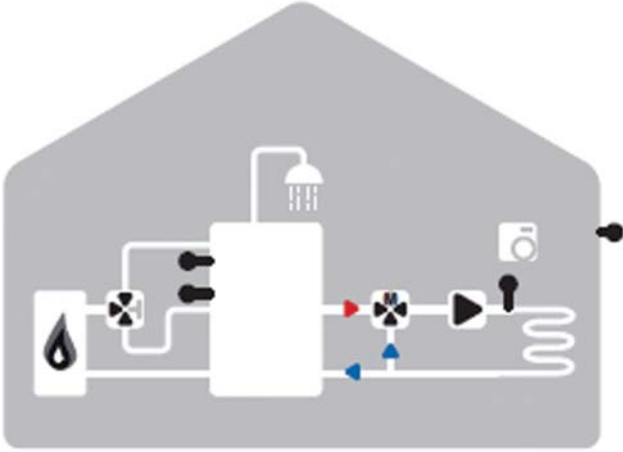

2. Mixed heating circuit with accumulation tank and DHW storage tank



3. Mixed heating circuit with DHW storage tank

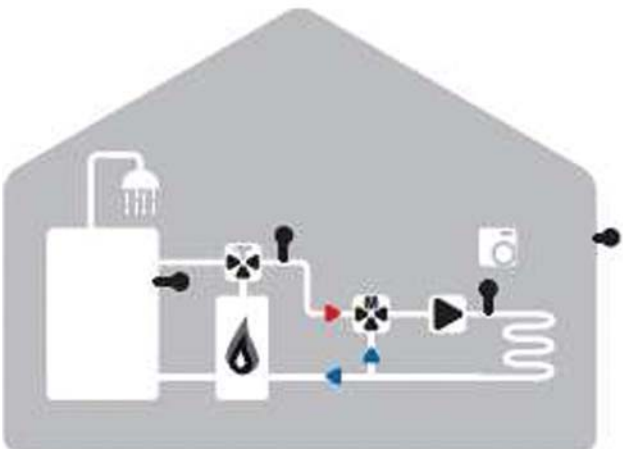

*In heating installations where domestic hot water is not needed, the DHW heating can be deactivated in menu 4 „**Operating mode**“. In heating installations without accumulation tank the sensor has to be installed in an appropriate position ahead of the mixer.*

C - INSTALLATION

C 1 - Wall installation

Install the controller in dry areas only and under the ambient conditions described in A 1.

Installation instructions:

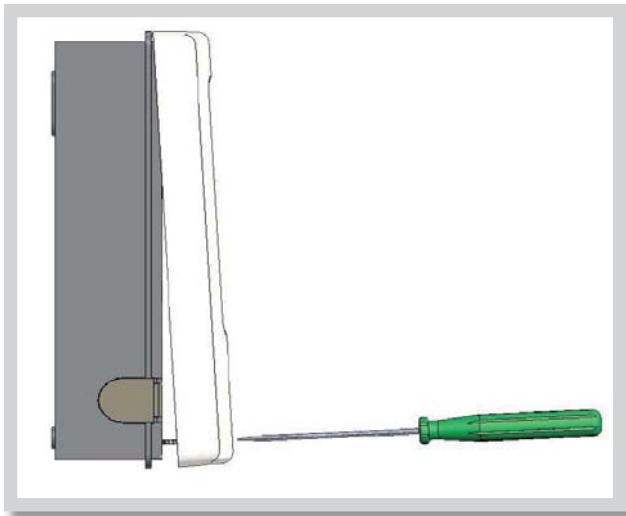

Fig. C 1.1

1. Unscrew cover screw completely.
2. Carefully pull upper part of housing from lower part.
3. Set upper part of housing aside, being sure not to touch the electronics when doing so.
4. Hold the lower part of the housing up to the selected position and mark the 3 mounting holes. Make sure that the wall surface is as even as possible so that the housing does not become distorted when it is screwed on.

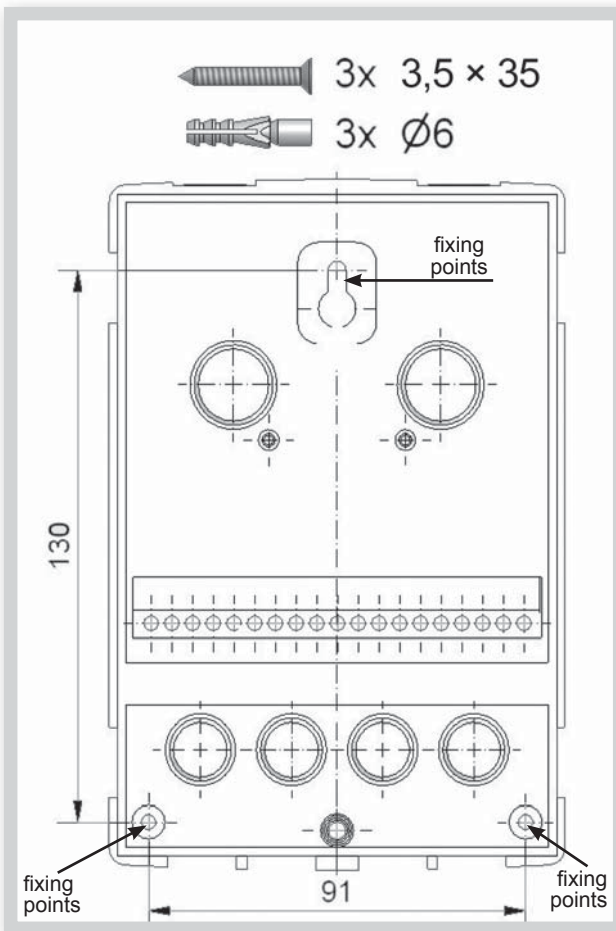

Fig. C 1.2

5. Using a drill and size 6 bit, drill 3 holes at the points marked on the wall and push in the plugs.
6. Insert the upper screw and screw it in slightly.
7. Fit the upper part of the housing and insert the other two screws.
8. Align the housing and tighten the three screws.

C 2 - Electric wiring



Low-voltage cables such as temperature sensor cables must be routed separately from mains voltage cables. Feed temperature sensor cables only into the left-hand side of the unit, and mains voltage cables only into the right-hand side.



The controller is not equipped with a mains switch. For this purpose please use e.g. a circuit breaker. The cables being connected to the unit must not be stripped by more than 55 mm, and the cable jacket must reach into the housing just to the other side of the strain relief.

Wiring instructions:

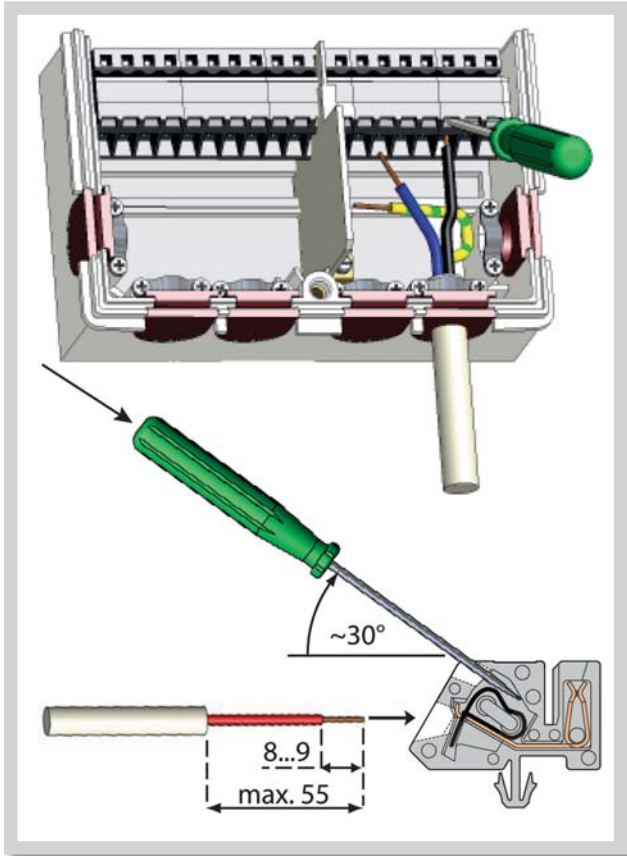

1. Make sure the circuit breaker is in off position and power supply is off.
2. Open the controller.
3. Strip the cable by 55 mm max., insert and fit the cable strain relief. Strip the last 8-9 mm of all the wires (C.2.1).
4. Press the terminals e.g. with a screwdriver (Fig. C.2.1) and wire the cables following the diagrams in section D.
5. Lock the housing lid onto the top margin of its bottom counterpart, push the cables inside and close the housing gently. Secure with the screw.
6. Switch on mains voltage and place controller in operation.

Fig. C 2.1

C 3 - Installing the temperature sensors

The controller operates with Pt1000 temperature sensors.



*Max. sensor lead length is 30 m and its cross section at least 0.75 mm².
Make sure that there is no contact resistance! Use immersion or pipe-mounted sensors.*

The temperature sensor cables must be routed separately from mains voltage cables!



As default, S6 is jump-wired with S terminal in order to keep functions of the heating circuit in operation. If the jumper gets removed, the heating circuit stops heating. Should a RC21 remote controller be used, the jumper at S6 shall be removed. If an external thermostat is connected, its electrical contacts shall be of floating type and low resistance = circa 0 Ohm.

D - Electric wiring

Sensor side - max 12V

Mains side - 230V 50Hz



- Temperature sensors S1 - S6 (polarity freely selectable)
- Optional additional functions Z1/Z2

Terminal:

-
- S1
- S2
- S3
- S4
- S5
- S6
- +
- Z1
- Z2

connection for:

- jumper terminal block S-
- sensor 1 outdoor sensor
- sensor 2 heating water
- sensor 3 DHW
- sensor 4 accumulation tank
- sensor 5 indoor sensor
- sensor 6 remote controller*
- free
- optional / expansion
- optional / expansion

Use terminal block S- for connecting the sensor earths of S1-S6. The polarity is freely selectable. The sensors S3-S6 are optional, depending on the hydraulic variant chosen.

- Protective conductor PE, metal terminal block
 - Neutral conductor terminal block N
 - Mains phase conductor L
 - Switch output R1-R4
 - Floating contact at R5/R5I
- Caution: Only suitable for 230V!*

Terminal:

- N
- L
- R1
- R2
- R3
- R4
- R5
- R5I
- PE

connection for:

- jumper terminal block N
- mains phase conductor L
- heating circuit pump
- mixing valve opens
- mixing valve closes valve / DHW pump
- add. heating
- add. heating
- The PE protective conductor must be connected to the PE metal terminal block!

**Note: If the RC21 remote controller or another room thermostat is connected, the bridge at S6 has to be removed.*

E - CONTROLLER USE

E 1 - Display and input



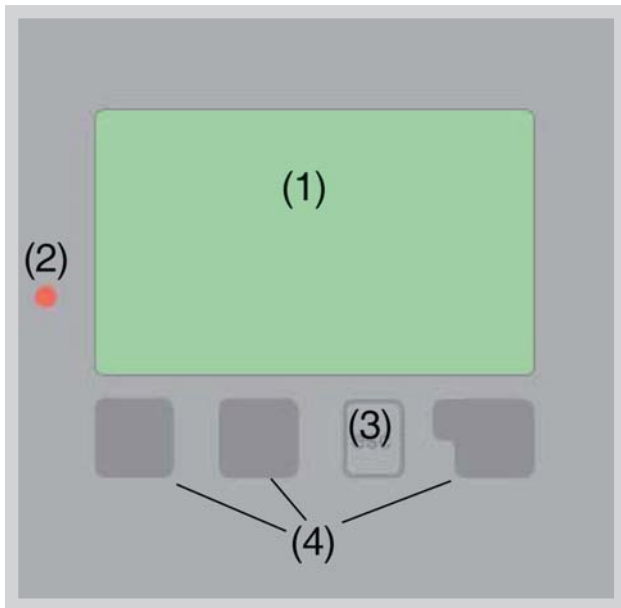









The display **(1)** shows graphic and text info on the hydraulic variant, set and measured values and other text info.



The LED lamp (2):

- lights up green -** if a relay is closed and the controller works right
- lights up red -** if the controller is set to automatic operation and all relays are open
- flashes slowly red -** if manual operation mode is set
- flashes quickly red -** if an error occurred

Examples of display symbols:

-  pump (rotates when active)
-  valve (direction of flow is black)
-  heating - day mode
-  heating - night mode
-  heating - comfort mode
-  day mode
-  night mode
-  day mode by RC21
-  night mode by RC21
-  reference value mode
reference value 14 day
-  warning / error message
-  new information available

Entries are made using four keys - „esc“ key **(3)** and three keys **(4)**, to which different functions are assigned depending on the situation.

The „esc“ key **(3)** is used to cancel an entry or to exit a menu.

If applicable there will be a request for confirmation as to whether the changes which have been made should be saved.

The function of each of the other three keys **(4)** is shown in the display line directly above the keys; the right-hand key generally has a confirmation and selection function.

Examples of key functions:

- +/- increase/decrease values
- ▼/▲ scroll menu up/down
- YES/NO confirm/reject
- Info additional information
- Back to previous screen
- OK confirm setting

E 2 - Menu sequence and menu structure

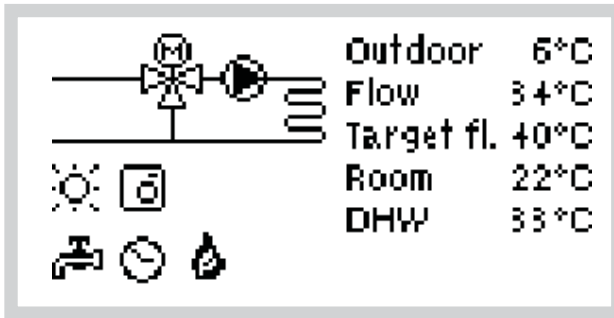

The graphics or overview mode appears when no key has been pressed for 2 minutes, or when the main menu is exited by pressing „**esc**“.

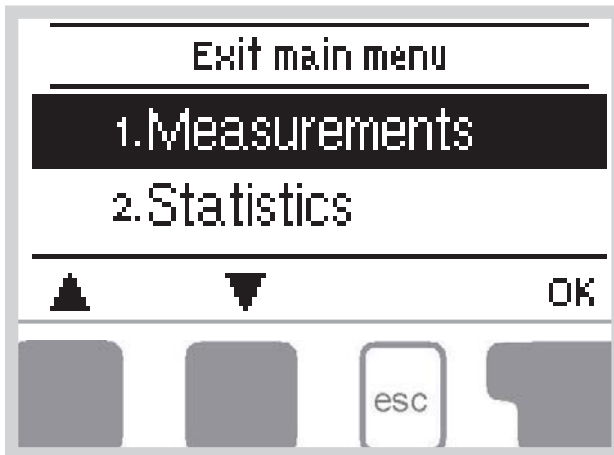

Pressing any key (**4**) in graphics or overview mode takes you directly to the main menu.

The following menu items are then available for selection there:

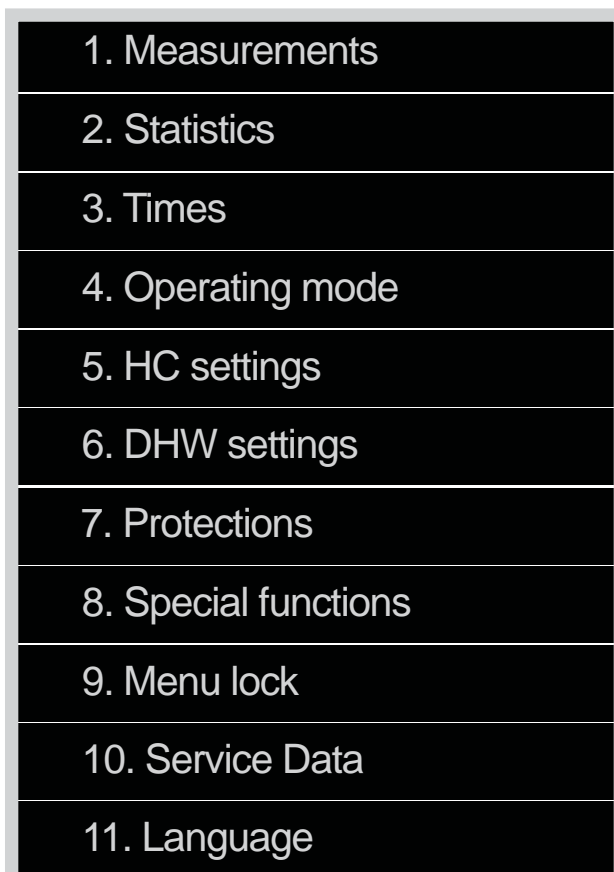

1. Current temperature values with explanations
2. Function control of the system with operating hours etc.
3. Operating times for heating circuit and DHW, setting the clock
4. Operating times for heating circuit and DHW, manual mode
5. Set parameters for the heating circuit
6. Set parameters for DHW
7. Anti-seizing protection, Frost protection, Anti-Legionella activation
8. Sensor calibration, Remote controller, Mixing valve etc.
9. Lock against unintentional setting changes
10. For diagnosis in the event of an error
11. Language selection

E 3 - Commissioning help - setup wizard



The first time the controller is turned on, language and clock need to be set.

After that a query appears as to whether you want to parameterize the controller using the commissioning help or not. The commissioning help can also be terminated or called up again at any time in the special functions menu. The commissioning help guides you through the necessary basic settings in the correct order, and provides brief descriptions of each parameter in the display. Pressing the „**esc**“ key takes you back to the previous value so you can look at the selected setting again or adjust it if desired. Pressing the „**esc**“ more than once takes you back step by step to the selection mode, thus cancelling the commissioning help. Finally, menu 4.2 under operating mode „**Manual**“ should be used to test the

switch outputs with the consumers connected, and to check the sensor values for plausibility. Then switch on automatic mode.

E 4 - Free commissioning

If you decide not to use the commissioning help, you should make the necessary settings in the following sequence:

- Menu 10. Language
- Menu 3. Time, date and operating times
- Menu 5. Settings for the heating circuit
- Menu 7. Protective functions if necessary
- Menu 8. Special functions if necessary

Finally, menu 4.2 under operating mode „**Manual**“ should be used to test the switch outputs with the consumers connected, and to check the sensor values for plausibility. Then switch on automatic mode.



Caution

Observe the explanations for the individual parameters on the following pages, and check whether further settings are necessary for your application.

F - PARAMETER SETTING

Measurements menu 1

F 1 - Measurements

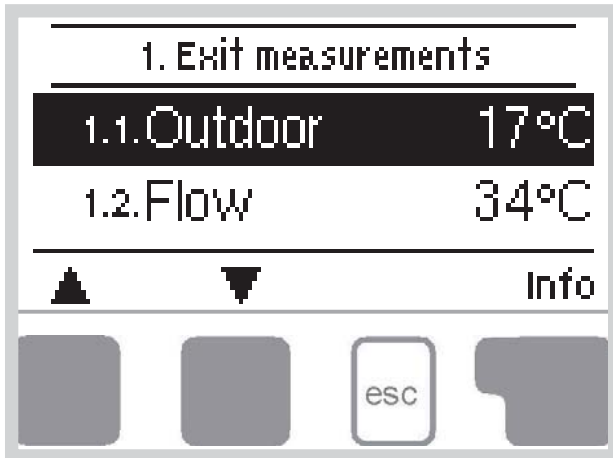

Menu „**1. Measurements**” serves to display the currently measured temperatures.

The menu is closed by pressing „**esc**” or selecting „**Exit measurements**”.



Selecting „**Info**” leads to a brief help text explaining the measurement values.

Selecting „**Overview**” or „**esc**” exits the Info mode.



*If „**Error**” appears on the display instead of the measurement value, then there may be a defective temperature sensor or its wiring.*

If the cables are too long or the sensors are not placed optimally, the result may be small deviations in the measurement values. In this case the display values can be compensated for using the function of sensor compensation - see 8.1.

What measurement values are displayed depends on the selected program, sensors connected and the specific controller model.

F 2 - Statistics

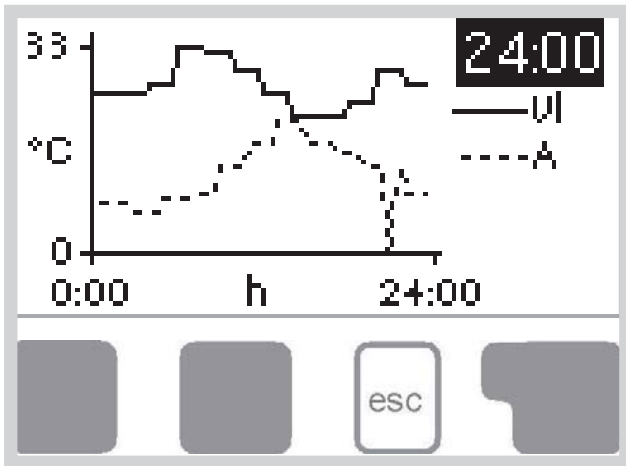

Menu „**2. Statistics**” is used for function control and long-term monitoring of the system.

The submenus described under 2.1-2.5 are available.

The menu is closed by pressing „**esc**” or selecting „**Exit statistics**”.



Caution

For system data statistics it is essential for the time to be set accurately on the controller. Please note that the clock continues to run for about 24 hours if the mains voltage is interrupted, and after that it has to be reset. Improper operation or an incorrect time may result in data being cleared, recorded incorrectly or overwritten.

The manufacturer accepts no liability for the recorded data!

F 2.1 - Today

Menu 2.1 (flow temperature for the present day)

In the graphical overview the characteristics of outdoor-and flow temperature for the present day is shown from 0-24h. The right button changes the unit of time and the two left buttons scroll through the diagram.

F 2.2 - 28 days

Menu 2.2 (flow temperature during the last 28 days)

In the graphical overview the characteristics of the outdoor and flow temperature during the last 28 days is shown. The right button changes the unit of time (Days) and the two left buttons scroll through the diagram.

F 2.3 - Operating hours heating circuit

menu 2.3

Display of operating hours of the heating circuit connected to the controller, and the date the measurement started.

F 2.4 - Operating hours DHW

menu 2.4

Display of operating hours of the DHW connected to the controller, and the date the measurement started.

F 2.5 - Operating hours additional heating

menu 2.5

Display of operating hours of the additional heating connected to the controller, and the date the measurement started.

F 2.6 - Error messages

menu 2.6

Display of the last three errors in the system with indication of date and time.

F 2.7 - Reset / clear

menu 2.7

Resetting and clearing the individual statistics. Selecting „**All statistics**” clears everything except for the error log.

F 3 - Times

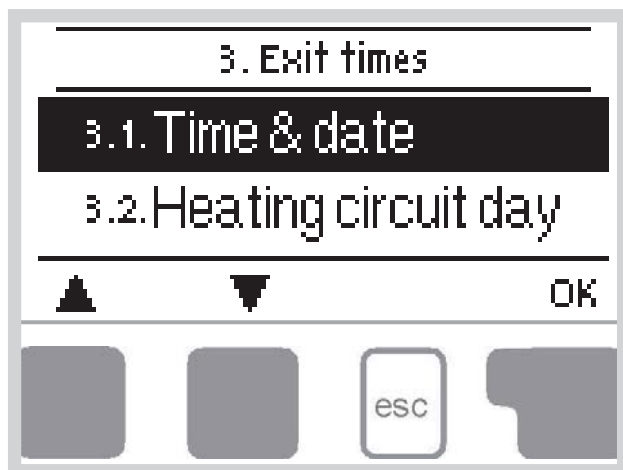

Menu „**3. Times**” is used to set the time, date and operating times for the heating circuit and DHW.



*The associated temperature reference values are specified in menu 5 „**Settings**”!*

The menu is closed by pressing „**esc**” or selecting „**Exit times**”.

F 3.1 - Time & Date

menu 3.1

This menu is used to set the current time and date.

**Caution**

For proper functioning of the controller and statistics for the system data it is essential for the time to be set accurately on the controller. Please note that the clock continues to run for about 24 hours if the mains voltage is interrupted, and after that has to be reset.

F 3.2 - Heating circuit day

menu 3.2

This menu is used to select the daytime mode times for the heating circuit; three time periods can be specified for each weekday and copied over to the following days.

Setting range: Three time ranges for each day of the week

Default: Mo-Su 6:00-22:00

Note: See 5. for the associated temperature settings

**Caution**

*Times that are not specified are automatically considered to be nighttime mode. The set times are only taken into account in the heating circuit operating mode „**Automatic**”.*

F 3.3 - Heating comfort

menu 3.3

This menu can be used to select a time range for each day of the week in which the heating circuit is supplied with an increased comfort temperature, e.g. for quick heating in the morning.

Setting range: One time range for each day of the week

Default: Mo-Su off.

Note: See 5. for the associated temperature settings

F 3.4 - Hot water enable

menu 3.4

This menu is used to select the times when the domestic hot water heating is enabled (sensor 3); three time periods can be specified for each weekday and copied over to the following days.

Setting range: Three time ranges for each day of the week

Default: Mo-Su 6:00-22:00

Note: See 6. for the associated temperature settings

**Caution**

*Times that are not specified are set to „**disabled**”.*

F 3.5 - Hot water AL

menu 3.5

A period of time can be set here for each week day when the domestic hot water part of the installation (sensor 3) is heated up to higher temperature, e.g. for anti Legionella function.

Setting range: One period of time for each day of the week

Default: Mo-Su off

Note: See 7.5. for the associated temperature settings

**Caution**

This anti-Legionella function does not provide complete protection against Legionella, because the controller is dependent on sufficient energy being fed in, and it is not possible to monitor the temperatures in the entire range of the storage tanks and the connected piping system. To provide complete protection against Legionella bacteria, it must be ensured that the temperature is raised to the necessary value (see section 5 for more info).

F 4 - Operating mode

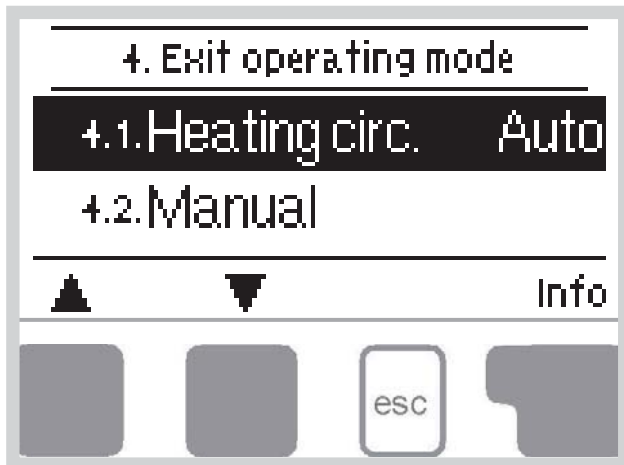

Menu „**4. Operating mode**” is used to specify the operating modes for the heating circuit. After an interruption of the mains voltage the controller automatically returns to the last operating mode selected!

The menu is closed by pressing „**esc**” or selecting „**Exit operating mode**”.



The controller works with the set operating times and the corresponding different reference flow temperature values only in the automatic mode.

F 4.1 - Heating circuit

menu 4.1

Auto = Automatic/Normal mode using the set times.

Continuous Day = The set values for day mode are used.

Continuous Night = The set values for night mode are used.

Reference value = Fixed flow temperature regardless of the outdoor temperature. The desired flow temperature has to be set in Menu 4.3.

14 day reference value = Specific fixed flow temperatures can be set for the next 14 days in menu 4.4. After 14 days, the reference temperature of the 14th day is used until the operating mode is changed.

Off. = Heating circuit is switched off (except Frost protection)

Setting range:

Auto, Continuous day, Continuous night, Reference value, 14 day reference, Off

Default: Automatic

F 4.2 - Manual

menu 4.2

In Manual mode the individual relay outputs and the connected consumers can be checked for proper functioning and correct assignment.



The operating mode „Manual” may only be used by specialists for brief function tests, e.g. during commissioning.

Function in manual mode:

The relays and thus the connected consumer are switched on and off by pressing a key, with no regard to the current temperatures and the parameters which have been set. At the same time, the current measurement values of temperature sensors are also shown in the display for the purposes of function control.

F 4.3 - Heating circuit reference

menu 4.3

If operating mode „**Reference value**” is selected, (Menu 4.1), the reference flow temperature has to be set here, regardless of the curve or outdoor temperature.

Setting range: 10 °C to 75 °C

Default: 30 °C

F 4.4 - 14 day reference

menu 4.4

If operating mode „**14 day reference value**” is selected (Menu 4.1), the reference flow temperature for each of the 14 days can be set here.

In the first menu 4.4.1 the starting time of the program is shown. To start the program, press restart.

Pressing „**restart**” again will reset the 14 day reference program and start it at day 1.

F 4.5 - Domestic hot water

menu 4.5

The domestic hot water heating can be activated here. „**Auto**” makes use of the times set in the „**times**” menu (see 3.4), „**On**” activates continuously, and „**Off**” switches the DHW heating off.

Setting range: Auto, On, Off

Default: Auto

F 5 - Settings HC

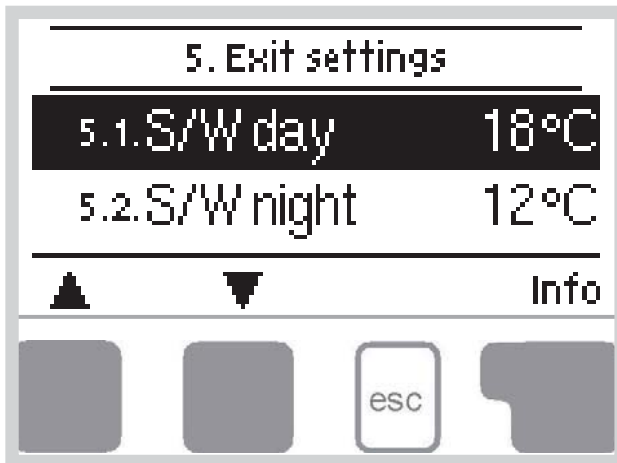

The necessary basic settings required for the control function of the heating circuit are made in menu „5. Settings HC”.

The menu is closed by pressing „esc” or selecting „Exit settings”.

F 5.1 - S/W Day menu 5.1 = Summer/Winter changeover in daytime mode

If this value is exceeded at outdoor sensor S1 during the daytime mode times, the controller automatically switches the heating circuit off = Summer mode.

If the outdoor temperature drops below this value, the heating circuit is switched on again = Winter mode.

Setting range: 0 °C to 30 °C

Default: 18 °C

F 5.2 - S/W Night menu 5.2 = Summer/Winter changeover in nighttime mode

If this value is exceeded at outdoor sensor S1 during the nighttime mode times, the controller automatically switches the heating circuit off = Summer mode.

If the outdoor temperature drops below this value, the heating circuit is switched on again = Winter mode.

Setting range: 0 °C to 30 °C

Default: 12 °C

F 5.3 - Curve menu 5.3 = Slope of the heating curve

The demand for heat is different due to differences in the type of building/insulation/type of heating/outdoor temperature. The characteristic curve is used to control the heat dissipation of the heating circuit relative to the outdoor temperature. The controller can make use of a normal straight curve (Setting simple) or a split curve (Setting split) that is divided into 2 parts by a split point. The straight curve can be set easily using one parameter. The characteristic curve for the split mode is adjusted in 3 steps.

In the simple setting the curve can be adjusted with the help of the graphic diagram. The slope is changed, and the calculated reference flow temperature is displayed for -12 °C.

Setting the split curve is more precise but more complicated. First the standard slope has to be set, after that the split point and finally the steepness of the curve after the split. While adjusting the curve, the steepness of the slope and the calculated reference flow temperature for -12 °C outdoor temperature is displayed.

Setting range:

Heating curve: simple or split / Default: simple

Slope: 0,0-3,0 / Default: 0,8

Split point at outdoor temp.: +10 °C ... -10 °C

Angle: differs, depends on steepness and split point

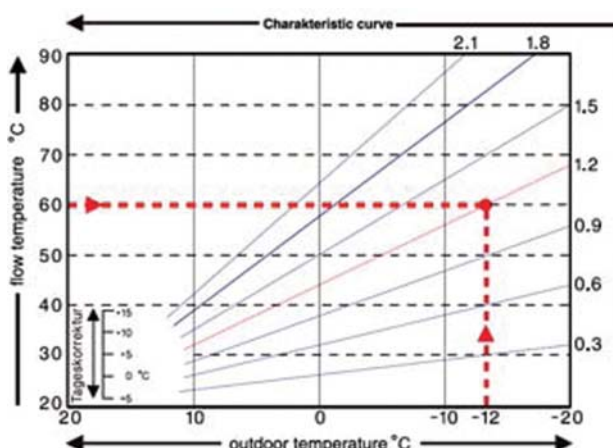

The diagram shows the influence of the selected characteristic curve steepness (standard curve) on the calculated reference flow temperature of the heating circuit. The correct curve is appointed by setting the intersection point of the calculated maximum flow temperature and the minimum outdoor temperature.

Maximum calculated flow temperature 60 °C at minimum outdoor temperature according to heat demand calculation -12 °C. The intersection results in a slope of 1.2.



Caution

The following settings can be used for parallel shift of the characteristic for certain time periods such as daytime and nighttime mode.

F 5.4 - Day correction menu 5.4 = paralelní posun křivky

The day correction means a parallel shift of the heating curve during the daytime operating hours, since depending on the outdoor temperature it is possible that the building may not be optimally heated with the set characteristic. If the characteristic is not optimized, the following situation may occur:

in hot weather - the rooms are too cold

in cold weather - the rooms are too hot

In this case, one should gradually reduce the characteristic slope in steps of 0.2, each time raising the day correction by 2-4 °C.

This procedure can be repeated several times as needed.

Setting range: from -10 °C to 50 °C

Default: 5 °C

F 5.5 - Night correction menu 5.5 = paralelní posun křivky

The night correction produces a parallel shift of the heating curve during the nighttime operating hours. If a negative value is set for the night correction, the reference flow temperature is lowered accordingly during the nighttime operating hours. In this manner, primarily at night, but also during the day when no-one is at home, energy can be saved.

Example: A day correction of +5 °C and a night correction of -2 °C produces a reference flow temperature in nighttime operation that is by 7 °C below that of daytime operation.

Setting range: from -30 °C to 30 °C

Default: -2 °C

F 5.6 - Comfort temperature boost menu 5.6 = paralelní posun křivky

The comfort temperature boost is added to the set day correction. In this manner it is possible to carry out quick heating and/or a higher temperature in the living spaces at a certain time each day.

Setting range: from 0 °C to 15 °C

Default: 0 °C = vyp.

F 5.8 - Reference / actual - menu 5.8 = switch-on hysteresis for additional heating

This setting determines the allowed undershoot of the heating circuit temperature under the calculated reference flow temperature. If the heating circuit flow temperature falls below the reference temperature by this value, the additional heating (R5) is activated after a delay of 5 minutes.

Setting range: -10 °C to 10 °C

Default: -2 °C



Caution

The additional heating (relay R5) is started when the flow temperature (in case of 2 heat circuits: one of the flow temperatures) is below the reference flow temperature for 5 minutes continuously.

F 5.9 - Reference / actual + menu 5.9 = switch-off hysteresis
(only if sensor S4 is connected)

This settings determines the allowed overstepping of the heating circuit temperature to the calculated reference flow temperature at sensor S4. If the temperature at S4 exceeds the reference flow temperature by this value, the additional heating is switched off.

Setting range: 1 °C to 10 °C

Default: 2 °C

F 6 - Settings DHW



The necessary basic settings required for the control function of the DHW heating are made in menu „6. Settings DHW“.

The menu is closed by pressing „esc“ or selecting „Exit settings“.

F 6.1 - DHW min.

menu 6.1 = Minimum domestic hot water temperature

If outside the time periods set in the „Times“ menu (see 3.4), i.e. the DHW is disabled, the temperature at the DHW sensor S3 drops below the one set here, the domestic hot water charging (relay 4) and the additional heating (relay 5) is switched on.

Setting range: 10 °C to 60 °C

Default: 45 °C

F 6.2 - DHW Setpoint

menu 6.2 = Minimum domestic hot water temperature

If the temperature at the DHW sensor S3 drops below the temperature set here and the DHW charging is enabled, the DHW charging (relay R4) and the additional heating (relay R5) are activated.

Setting range: 10 °C to 60 °C

Default: 45 °C

F 6.3 - DHW hysteresis

menu 6.3 = DHW hysteresis

DHW charging (relay R4) and additional heating (relay R5) are switched off when the temperature at DHW sensor S3 reaches the set values (see 6.1 and 6.2) plus the DHW hysteresis.

Setting range: 2 °C to 20 °C

Default: 10 °C

F V6.4 - Buffer HW load

menu 6.4 = Charge DHW from the accumulation tank

DHW charging via relay R4 directly from the accumulation tank is activated when the temperature at accumulation tank sensor S4 is at least 8 °C warmer than the DHW sensor S3.

F 7 - Protective functions



Menu „7. Protections” can be used by specialists to activate and set various protective functions.



This does not under any circumstances replace the safety facilities to be provided by the customer!

The menu is closed by pressing „esc” or selecting „Exit protections”

F 7.1 - Seizing protection

menu 7.1

If the anti-seizing protection is activated, the controller switches the pump and the valve on/off at 12:00 pm for 5 seconds to prevent seizing of the pump/valve after long periods of inactivity.

Setting range: on, off

Default: on

F 7.2 - Frost protection

menu 7.2

Frost protection function for the heating circuit. If the outdoor temperature at sensor S1 drops below 1 °C and the heating circuit is switched off, the controller switches it back on with the reference temperature set in menu 7.3 (min. flow temperature). As soon as the outdoor temperature exceeds 1 °C, the heating circuit is switched off again.

Setting range: on, off

Default: on



Switching the frost protection function off or setting the minimum flow temperature too low can lead to severe damage of the system.

F 7.3 - Min. flow temperature

menu 7.3

The minimum flow temperature is the lower limit for the characteristic curve/slope and as a result also for the reference flow temperature of the heating circuit. Additionally, the min. flow temperature is the reference flow temperature for the frost protection.

Setting range: 5 °C to 30 °C

Default: 15 °C

F 7.4 - Max. flow temperature

menu 7.4

This is used as the upper limit for the reference flow temperature of the heating circuit. Should the heating circuit temperature exceed this value, the heating circuit is switched off until the temperature drops below. This feature is used e.g. to protect underfloor heating.

Setting range: 30 °C to 105 °C

Default: 45 °C



For safety, an additional limiting thermostat must be provided which is connected to the pump in series.

F 7.5 - Anti Legionella

menu 7.5

When the anti Legionella function is active, the domestic hot water part at sensor S3 can be heated up to a specific temperature, provided that the energy is sufficient.

AL function - Setting range: On, Off / Default: Off

AL Tset - Setting range: 60 °C to 80 °C / Default: 70 °C

AL interval - Setting range: 1 to 28 days / Default: 7 days

AL heat: The last time the AL function completed successfully.

During the anti-Legionella function the storage tank is heated up to high temperatures which can lead to scalding and damage to the system.

The operating times for the AL function have to be set in the „Times” menu (see 3.5)

This anti-Legionella function does not provide complete protection against Legionella, because the controller is dependent on sufficient energy being fed in, and it is not possible to monitor the temperatures in the entire range of the storage tanks and the connected piping system. To provide complete protection against Legionella bacteria, it must be ensured that the temperature is raised to the necessary temperature, and at the same time there must be water circulation in the storage tank and piping system by means of other additional energy sources and control units.

7.6 Discharge protection

menu 7.6

To prevent unnecessary cool down of the system, the heating circuit is switched off when the buffer temperature drops below reference temperature.

Settings range: On, Off / Default: Off

F 8 - Special functions



Menu „**8. Special functions**“ is used to set basic items and expanded functions.



The settings in this menu should only be made by a specialist.

The menu is closed by pressing „**esc**“ or selecting „**Exit special functions**“.

F 8.1 - Sensor calibration menu 8.1 / 8.1.1 – 8.1.6

Deviations in the temperature values displayed, for example due to cables which are too long or sensors which are not positioned optimally, can be compensated for manually here. The settings can be made for each individual sensor in steps of 0.5 °C.

Offset S1...S6 per settings range : -10 °C...+10 °C

Default: 0 °C



Settings are only necessary in special cases at the time of initial commissioning by the specialist. Incorrect measurement values can lead to unpredictable errors.

F 8.2 - Commissioning menu 8.2

The commissioning help guides you through the necessary basic settings in the correct order, and provides brief descriptions of each parameter in the display.

Pressing the „**esc**“ key takes you back to the previous value so you can look at the selected setting again or adjust it if desired. Pressing the „**esc**“ more than once takes you back step by step to the selection mode, thus cancelling the commissioning help (see also E3).



May only be started by a specialist during commissioning! Observe the explanations for the individual parameters in these instructions, and check whether further settings are necessary for your application.

F 8.3 - Factory settings menu 8.3

All of the settings that have been made can be reset, thus returning the controller to its delivery state.



The entire parametrization, statistics, etc. of the controller will be lost irrevocably. The controller must then be commissioned once again.

F 8.4 - Expansions menu 8.4

This menu can only be selected and used if additional options or expansion modules have been built into the controller. The associated supplementary installation, mounting and operation instructions are then included with the specific expansion.

F 8.5 - Mixer menu 8.5

Settings are only necessary at the time of initial commissioning by the specialist. Incorrect measurement values can lead to severe unpredictable errors.

F 8.5.1 - Turn time menu 8.5.1

The mixing valve is switched on i.e. is opening or closing for the time span set here, then the temperature is measured to control the flow temperature.

Settings range: 0.5 sec to 3 sec.

Default: 2 s

F 8.5.2 - Pause-Factor

menu 8.5.2

The calculated pause time of the mixer is multiplied with the value set here. If the pause factor is „1”, the normal pause time is used, „0.5” will use half the normal pause time, „4” would quadruple the pause time.

Setting range: 0.1 to 4.0

Default: 1.0

F 8.5.3 - Increase

menu 8.5.3

If the temperature rises very fast, this value is added to the measured flow temperature so that the mixer's reaction is faster.

If the measured temperature does not rise any more, the measured value is used again. The measurement occurs once every minute.

Setting range: 0 to 20

Default: 8

F 8.6 - Room controller

menu 8.6

The settings necessary for the optional room controller RC21 are made in this menu. The 3 modes „**continuous day**”, „**continuous night**” and „**Time controlled/automatic**” can be switched at the RC21. Additionally the reference temperature of the flow can be parallel shifted by turning the control wheel. If the wheel is set to minimum, only the minimum values that can be set in the protective functions menu will be used.



Caution

In the operating modes “Reference value” and 14day ref.” the remote adjuster is without function.

F 8.6.1 - Room controller - setting

menu 8.6.1

This value is used to appoint the amount of influence (in %) the room temperature has on the reference flow temperature. For every degree of deviation of the room temperature from the reference room temperature the percentage of the calculated reference flow temperature set here is added to or, respectively, subtracted from the reference flow temperature. As long as it is within the limits of the min. and max. flow temperatures that can be set in the protective functions.

Setting range: 0 % to 20 %

Default: 0

Example:

Reference room temp.: e.g. 25 °C;

room temp.: e.g. 20 °C = 5 °C deviation.

Calculated reference temp.: e.g. 40 °C: Room controller: 10 % = 4 °C.

5 × 4 °C = 20 °C. According to this 20 °C are added to the reference flow temperature, resulting in 60 °C.

If the value is higher than the one set in max. flow temp., the resulting temperature is only the one set in max. flow temp.

F 8.6.2 - Room reference day

menu 8.6.2

The desired room temperature for day mode. As long as this temperature is not reached, the reference flow temperature is raised or respectively lowered according to the percent setting in „**room controller**”. If „**room controller**” is set to 0 %, this function is deactivated.

Setting range: 10 °C to 30 °C

Default: 20 °C

F 8.6.3 - Room reference night

menu 8.6.3

The desired room temperature for night mode. As long as this temperature is not reached, the reference flow temperature is raised or respectively lowered according to the percent setting in „**room controller**”. If „**room controller**” is set to 0 %, this function is deactivated.

Setting range: 10 °C to 30 °C

Default: 20 °C

F 9 - Menu lock

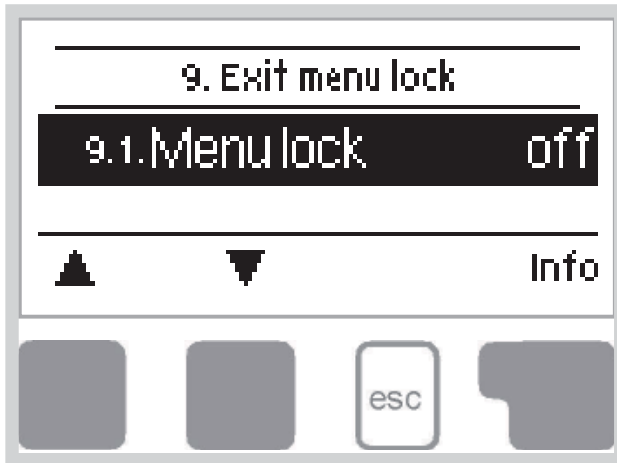

Menu „**9. Menu lock**” can be used to secure the controller against unintentional changing of the set values.

The menu is closed by pressing „**esc**” or selecting „**Exit menu lock**”.

The menus listed below remain completely accessible despite the menu lock being activated, and can be used to make adjustments if necessary:

- F 1 - Measurements
- F 2 - Statistics
- F 3 - Times
- F 8 - Menu lock
- F 9 - Service values

To block the other menus, select „**Menu lock on**”. To enable the menus again, select „**Menu lock off**”.

Setting range: on, off

Default: off

F 10 - Service values

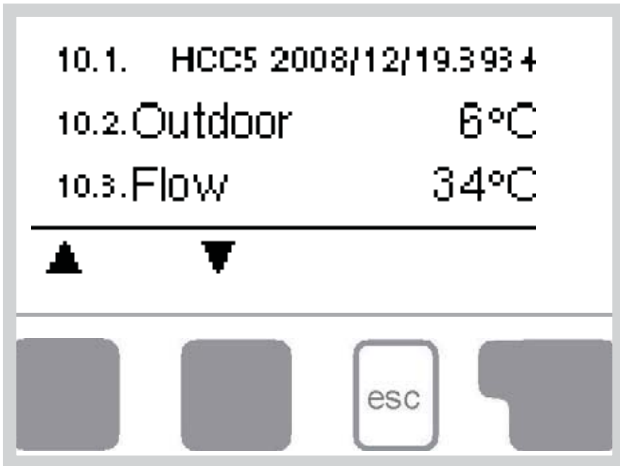

The menu „10. Service values” can be used for remote diagnosis by a specialist in the event of an error etc.



Caution

The data may be entered e.g. into the following table.

The menu can be closed at any time by pressing „esc”.

10.1.		10.31.	
10.2.		10.32.	
10.3.		10.33.	
10.4.		10.34.	
10.5.		10.35.	
10.6.		10.36.	
10.7.		10.37.	
10.8.		10.38.	
10.9.		10.39.	
10.10.		10.40.	
10.11.		10.41.	
10.12.		10.42.	
10.13.		10.43.	
10.14.		10.44.	
10.15.		10.45.	
10.16.		10.46.	
10.17.		10.47.	
10.18.		10.48.	
10.19.		10.49.	
10.20.		10.50.	
10.21.		10.51.	
10.22.		10.52.	
10.23.		10.53.	
10.24.		10.54.	
10.25.		10.55.	
10.26.		10.56.	
10.27.		10.57.	
10.28.		10.58.	
10.29.		10.59.	
10.30.		10.60.	

F 11 - Language



Menu „**11. Language**” can be used to select the language for the menu guidance. This is queried automatically during initial commissioning. Language selection is not available in every device design!

G - DEFECTS AND MAINTENANCE

G 1 - Malfunctions with error messages

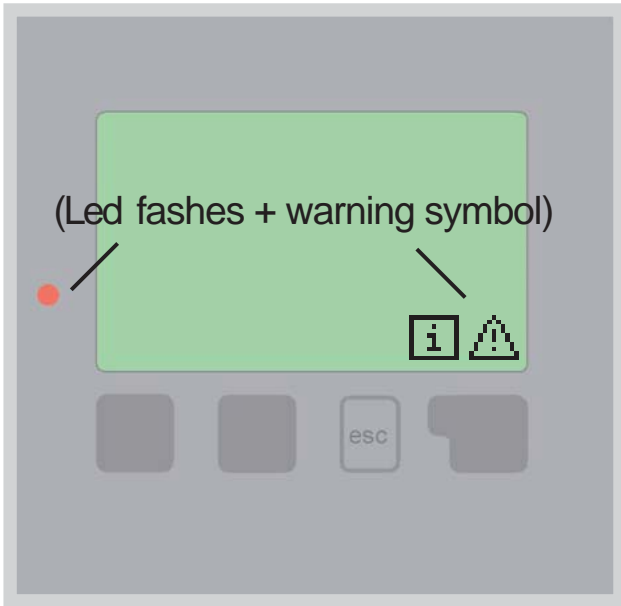

If the controller detects a malfunction, the red light flashes and the warning symbol also appears in the display. If the error is no longer present, the warning symbol changes to an info symbol and the red light no longer flashes.

To obtain more detailed information on the error, press the key under the warning or info symbol. Do not try to deal with this yourself. Consult a specialist in the event of an error!

Possible error messages:

Sensor x defective

Restart
(Information only)

Notes for the specialist:

Means that either the sensor, the sensor input at the controller or the connecting cable is/was defective. (Resistance table see chap. A6)

Means that the controller was restarted, for example due to a power failure. Check the date&time!

G 2 - Replacing the fuse



Caution

Repairs and maintenance may only be performed by a specialist. Before working on the unit, switch off the power supply and secure it against being switched on again! Check for the absence of power!

Only use the supplied spare fuse or a fuse of the same design with the following specifications: T2A 250V

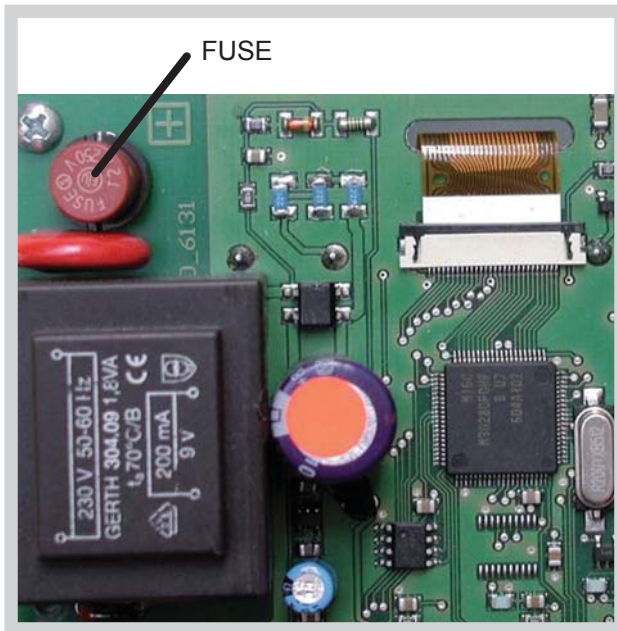

Fig. 3.1.1

If the mains voltage is switched on and the controller still does not function or display anything, then the internal device fuse may be defective. In that case, open the device, remove the old fuse and check it. Exchange the defective fuse for a new one, locate the external source of the error (e.g. pump) and exchange it. Then first recommission the controller and check the function of the switch outputs in manual mode as described under 9.2.

G 3 - Maintenance

In the course of the general annual maintenance of your heating system you should also have the functions of the controller checked by a specialist and have the settings optimized if necessary.

Performing maintenance:

- Check the date and time (see 3.1.)
- Assess/check plausibility of statistics (see 2)
- Check the error memory (see 2.6)
- Verify/check plausibility of the current measurement values (see 1)
- Check the switch outputs/consumers in manual mode (see 4.2)
- Possibly optimize the parameter settings

G 4 - Useful hints and tricks



The service values (see 10) include not only current measurement values and operating states, but also all of the settings for the controller. Write the service values down just once after commissioning has been successfully completed.



In the event of uncertainty as to the control response or malfunctions the service values are a proven and successful method for remote diagnosis. Write the service values down (see 15) at the time that the suspected malfunction occurs. Send the service value table by fax or e-mail with a brief description of the error to the specialist.



To protect against loss of data, record any analyses and data that are particularly important to you at regular intervals (see 7).

G 5 - Disposal

IMPORTANT INFORMATION ON DISPOSAL IN COMPLIANCE WITH THE EUROPEAN DIRECTIVE 2002/96/EC

European Directive 2002/96/EC requires that the equipment bearing this symbol on the product and/or its packaging must not be disposed of with unsorted municipal waste. The symbol indicates that this product should be disposed of separately from regular household waste streams. It is your responsibility to dispose of this and other electric and electronic equipment via designated collection facilities appointed by the government or local authorities. Correct disposal and recycling will help prevent potential negative consequences to the environment and human health. For more detailed information about the disposal of your old equipment, please contact your local authorities, waste disposal service, or the shop where you purchased the product.



WEEE registration number: 02771/07-ECZ

01/2013

REGULUS spol. s r.o.
Do Koutů 1897/3
143 00 Praha 4

<http://www.regulus.eu>
E-mail: sales@regulus.cz