

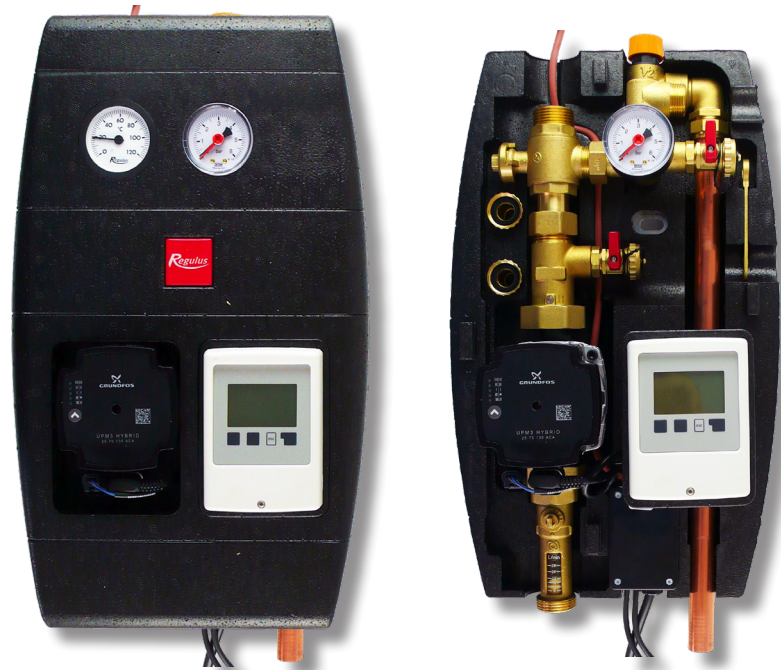

www.regulus.eu



CSE SOL G SRS1 T-E

Installation and Operation Manual
CSE SOL G SRS1 T-E SOLAR PUMP STATION

EN

CSE SOL G SRS1 T-E

1. Introduction

CSE SOL G SRS1 T-E Solar Pump Station is fitted with a solar pump of the latest generation that permits flow control either internally by selecting a suitable mode or externally through PWM signal. The complicated setting of the right flow rate is not needed when the PWM signal is used, the pump station keeps adjusting it automatically, depending on the actual solar radiation. This means that the solar thermal system always works with the maximum possible efficiency.

Thanks to a direct connection of the heating element into the special socket in the pump station, a long power cable for the pump station and a cable ready to connect to a solar sensor, the installation is easy and fast, no qualified electrician is needed.

2. Pump Station Description

Main Features	
Použití	<p>This solar pump station contains all components necessary for current and efficient operation incl. complete electrical wiring. It is necessary to connect only the collector temperature sensor.</p> <p>An electric heating element of up to 3 kW output can be connected to the pump station. The pump station is equipped with a special socket for this purpose.</p> <p>No heating element is included in supply.</p>
Popis	<p>The pump station consist of a UPM3 Hybrid 25-70 pump, SRS1 T controller, check and safety valves, 2 ball valves, pressure gauge, thermometer, el. wiring, insulation and installation kit.</p> <p>The pump station further involves:</p> <ul style="list-style-type: none"> ● connection point for an expansion vessel ● safety valve outlet, incl. extension piping terminating under the pump station for easier connection ● ball valves for filling, draining and topping up a solar thermal system ● special socket to connect a heating element of max. output of 3 KW / 230V ● two connected temperature sensors for solar consumer (4m cable) ● solar temperature sensor (2m cable, silicone insulation) ● 230V power cable w. el. plug (3m cable, PVC insulation)
Installation	on a tank or wall
Working fluid	water-glycol mixture (max. 1:1)

Codes corresponding to connection sizes

Connection	G 3/4" M	G 1" M
Flow measurement range	2-12 l/min	8-28 l/min
Code	18970	18962

3. Pump Station Data

Data for CSE SOL G SRS1 T-E Pump Station	
Max. fluid working temperature	110 °C
Max. working pressure	6 bar
Min. system pressure	1.3 bar with the pump stopped
El. heating element	resistive load max. 3000 W / 230 V (see accessories)
External circulation pump	induction load max. 3000 VA / 230 V
Power supply	230 V, 50 Hz
IP rating	IP20
Ambient temperature	5 - 40 °C
Max. relative humidity	85% at 25 °C
Overall dimensions	470 x 265 x 120 mm
Total weight	7.1 kg

Min. values of working pressure**

Values of min. working pressure at the pump suction port depending on temperature	0.8 bar at 50 °C 1.2 bar at 90 °C 1.8 bar at 110 °C
---	---

** this condition is met for current installations when the initial system pressure is set following the formula (see the Instructions for solar collectors): $p = 1,3 + 0,1 \cdot h$ [bar] where h... is the height from pressure gauge to the middle of collector array [m]

Pump station internal wiring

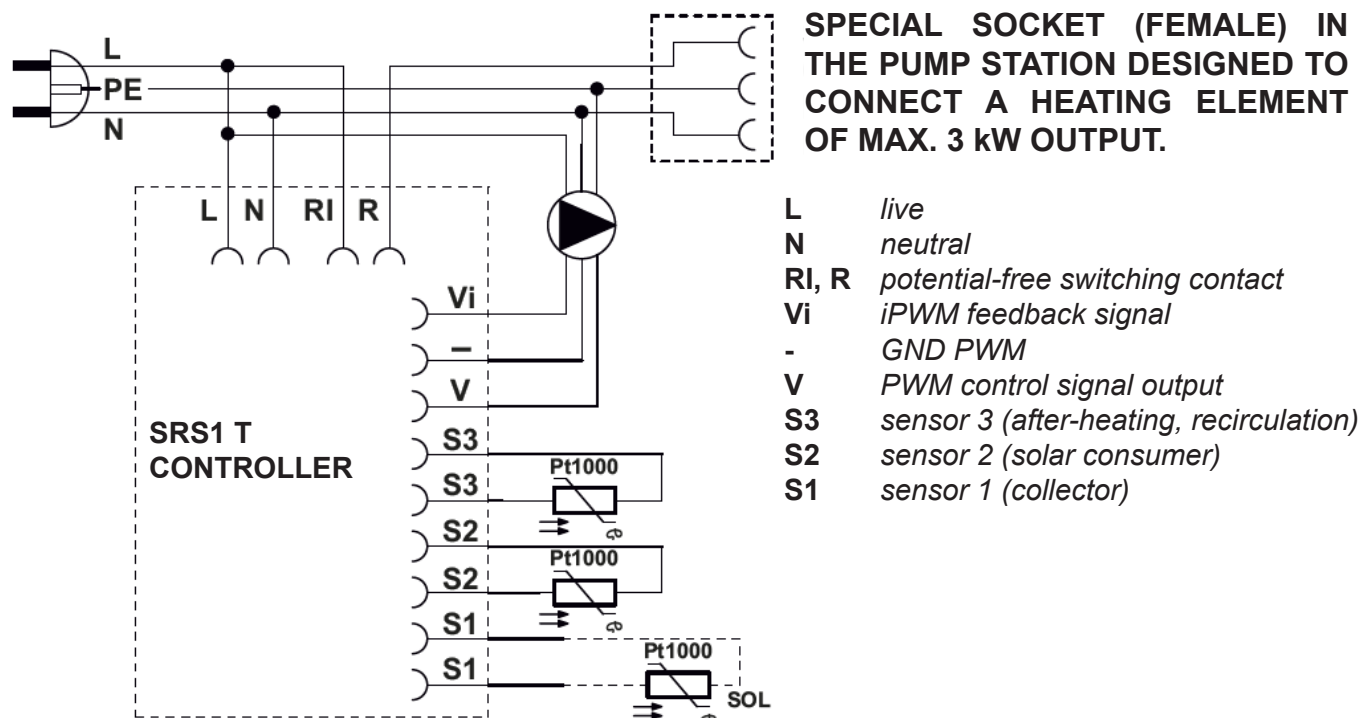

Temperature Resistance Table for Pt1000 Sensors

°C	0	10	20	30	40	50	60	70	80	90	100
Ω	1000	1039	1077	1116	1155	1194	1232	1270	1308	1347	1385

3.1 Pump Station Pressure Drop Graph

Flowmeter · 2-12 l/min

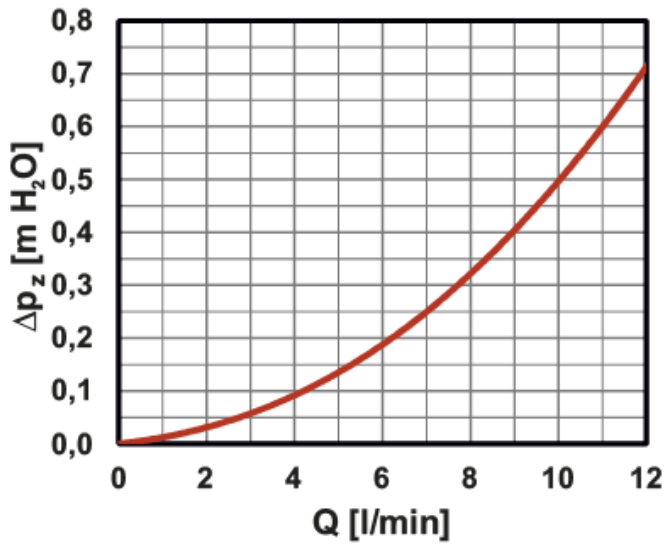

Flowmeter · 8-28 l/min

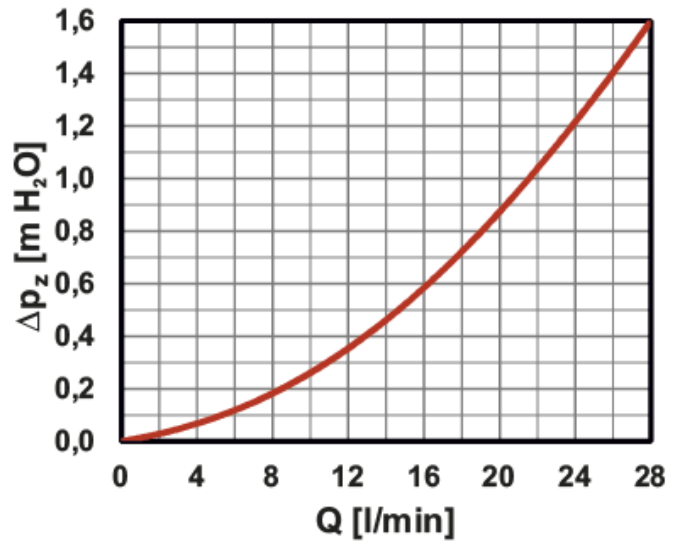

4. Pump Station Components

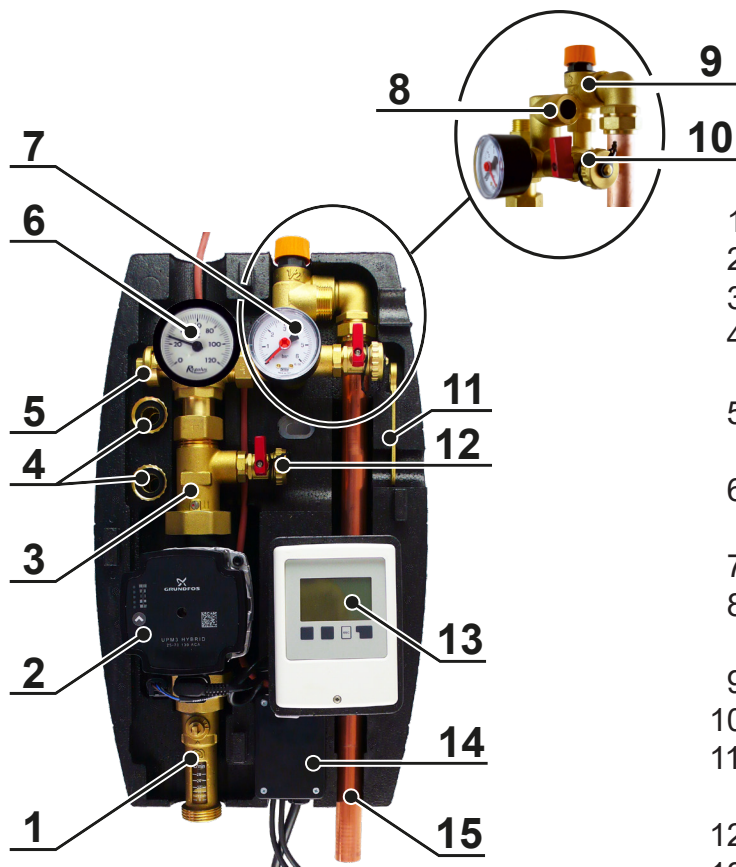

- 1 - FLOWRATE INDICATOR W. BALL VALVE
- 2 - CIRCULATION PUMP
- 3 - CHECK VALVE
- 4 - HOSE TAIL FOR FILLING AND DRAINING THE SYSTEM
- 5 - BALL VALVE W. SIDE OUTLET FOR SAFETY GROUP
- 6 - THERMOMETER (IN THE UPPER PART OF INSULATION)
- 7 - PRESSURE GAUGE
- 8 - EXPANSION VESSEL CONNECTION POINT, 3/4" M
- 9 - 6 BAR SAFETY VALVE
- 10 - FILLING BALL VALVE
- 11 - SPANNER FOR CONTROL OF BALL VALVE W. SIDE OUTLET
- 12 - DRAIN BALL VALVE
- 13 - SRS1 T ELECTRONIC CONTROLLER
- 14 - TERMINAL BOX WITH EL. SOCKET TO CONNECT A HEATING ELEMENT
- 15 - SAFETY VALVE WASTE PIPE, Ø22 mm

4.1 Check Valve

The non-return valve prevents the tank from cooling down due to gravity circulation when the sun is not shining. It is located between the ball valves and can therefore be removed and cleaned without having to drain the solar fluid from the entire circuit.

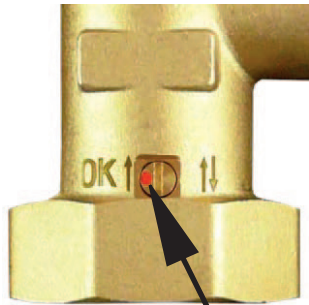

If the mark is on the left, the check valve is set to the position for normal operation. If you need to open the valve (e.g. to drain fluid from the system), turn the check valve control with the red dot to the right. This will deactivate the check valve function.

! For correct operation of the pump station during normal use it is important to have the check valve control always in the right position, i.e. the mark on the left (see pic.).

Right position during operation.

4.2 Ball Valves

Ball valves are used to separate the pump station from the solar circuit. During servicing (including cleaning of the check valve) there is no need to drain the fluid from the solar system. For greater rigidity of the hydraulic part of the pump station, the upper ball valve is attached to the fixing back plate.

The upper ball valve is operated by a lever which is not located on the valve during operation. A wrench or pliers must be used to operate the lower ball valve, which is part of the flow indicator. Turning the lever or the key or pliers a quarter turn to the right closes the ball valve. It opens when the lever is turned to the left. Before closing / opening the ball valve, it is necessary to remove the front part of the insulation. As a result, closing the system is reserved for installation or service technicians only. Thus, the user cannot simply close the solar circuit and cause stagnation and subsequent degradation of the solar fluid.

The ball valves are equipped with a packing with two O-rings with dimensions of 8.7 x 1.8 mm that can be easily replaced by removing the control element with stop ends and loosening the packing nut with a # 21 wrench.

The safety valve, expansion vessel and upper filling ball valve always remain connected to the solar thermal system, even if the ball valves are closed! For this reason, never try to separate them from the filled solar system, as there is a risk of serious injury and damage to the solar system!

Never close the drain line of the safety valve, it must always be free for any liquid leaking from the safety valve!

5. Accessories

Accessories (not included in supply)	Code
ETT-N heating element w. connector, 2 kW	16942
ETT-N heating element w. connector, 3 kW	16943
Connector for CSE SOL SRS1 T-E	16940
Straight compression fitting, Cu 22 x Cu 22	7629
Straight Compression Fitting Adaptor, Cu 22 x G 3/4" M	13695



These accessories are not included in supply. An ETT-N heating element with connector (16942 or 16943) is needed when the pump station is to be used following the hydraulic variant 1 (chapter 7.1). The pipe fittings (7629 and 13695) are intended for connecting a waste pipe to the safety valve.

6. Installation Options

The solar pump station is designed to be mounted on a wall or on a tank. There are two fixing openings in the rear part of the insulation. The lower one is accessible only when the electronic controller is removed from rear part of the insulation (see the pic. below).

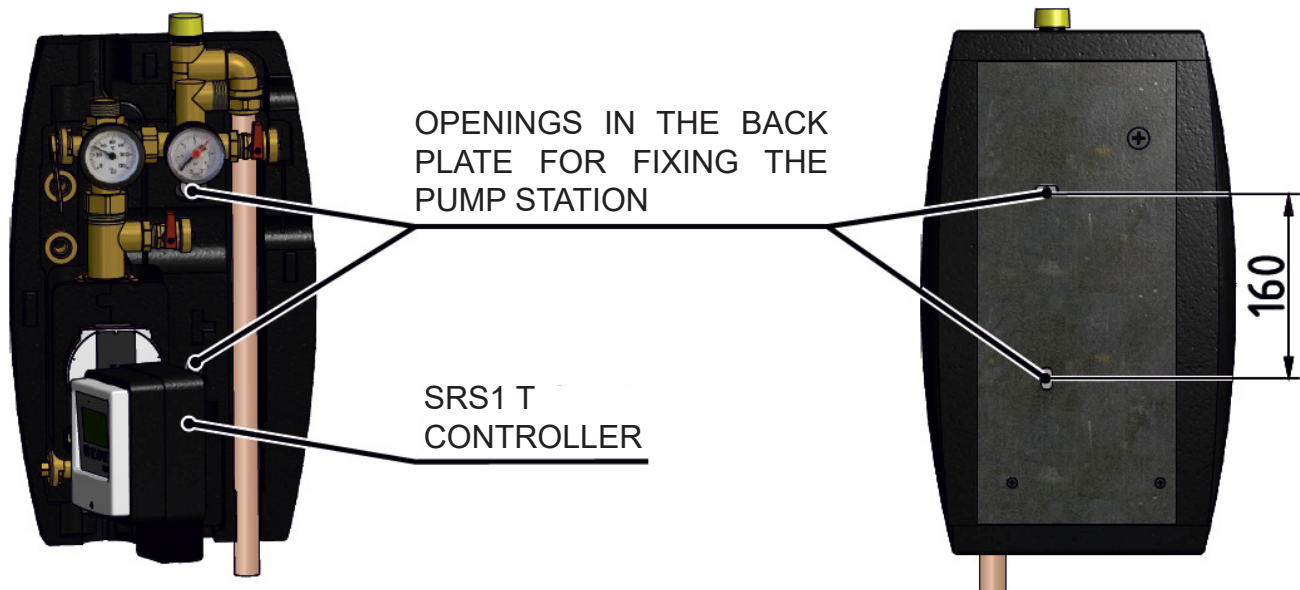

The supply involves an installation kit that is used to fix the pump station in its place.



7. Pump Station Connection Diagram

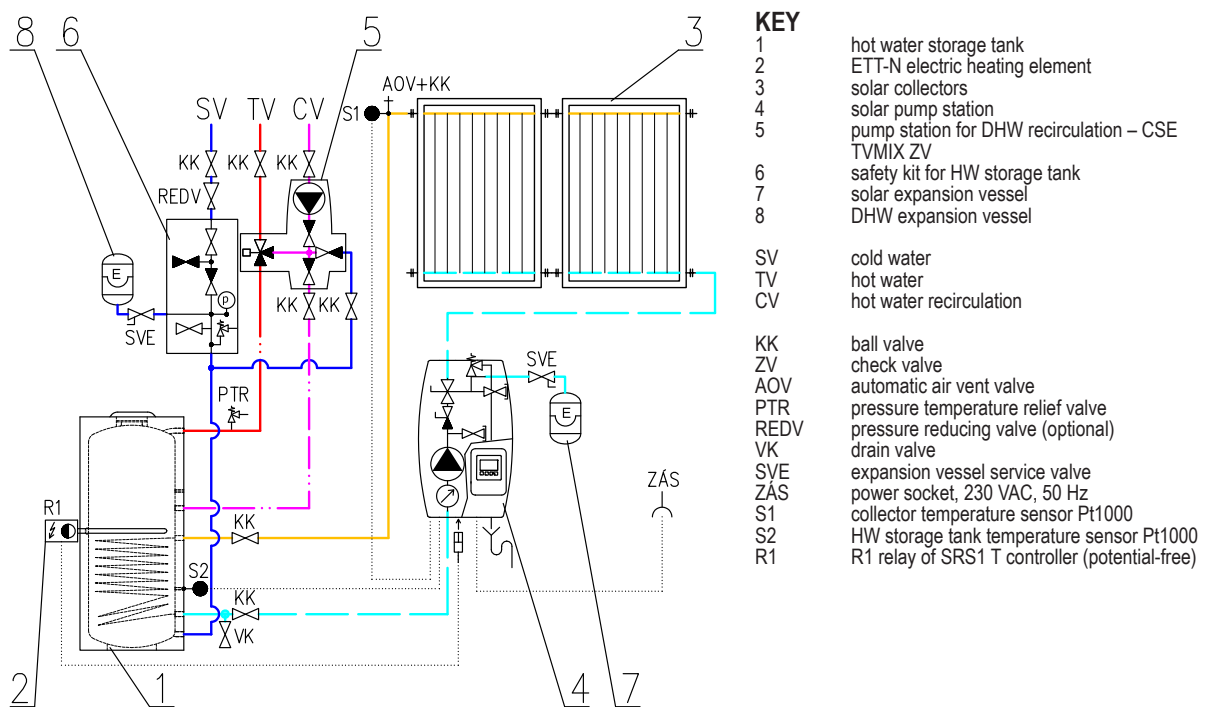

7.1 Overview of Hydraulic Variants

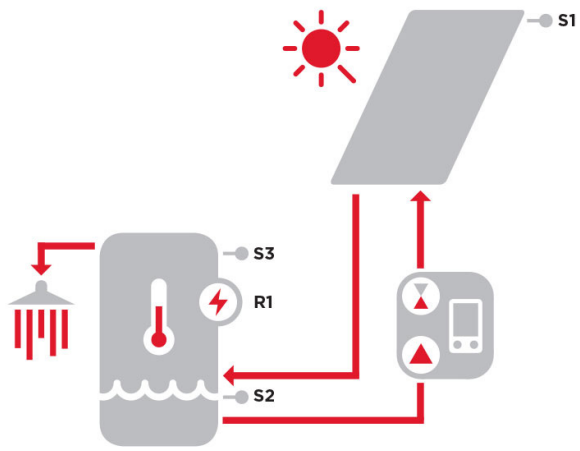

1

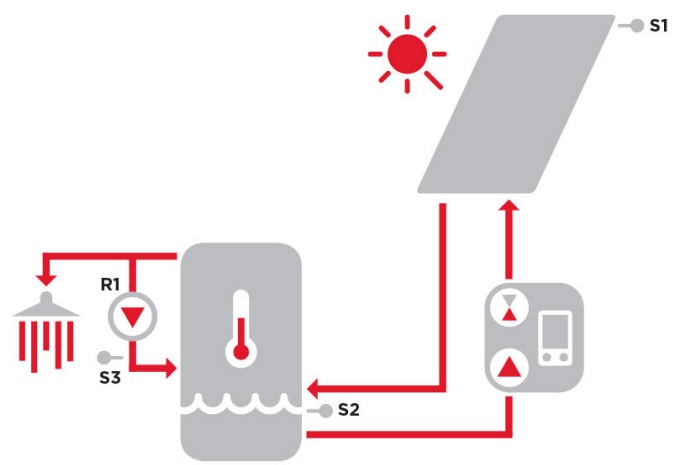

3

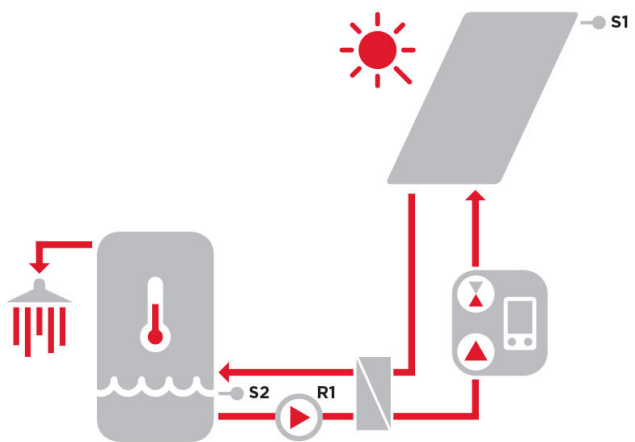

5

8. UPM3 HYBRID 25-70 Pump

Pump control

The circulation pump can be controlled:

- internally without PWM signal by selecting a proper mode and pump curve.
- externally by PWM C control signal (profile for solar systems)

WARNING – IMPORTANT

The pump permits to be controlled also by PWM A signal (profile for use in heating systems). This mode must not be used for solar thermal systems. Using the PWM A pump profile would cause system damage.

Performance curves

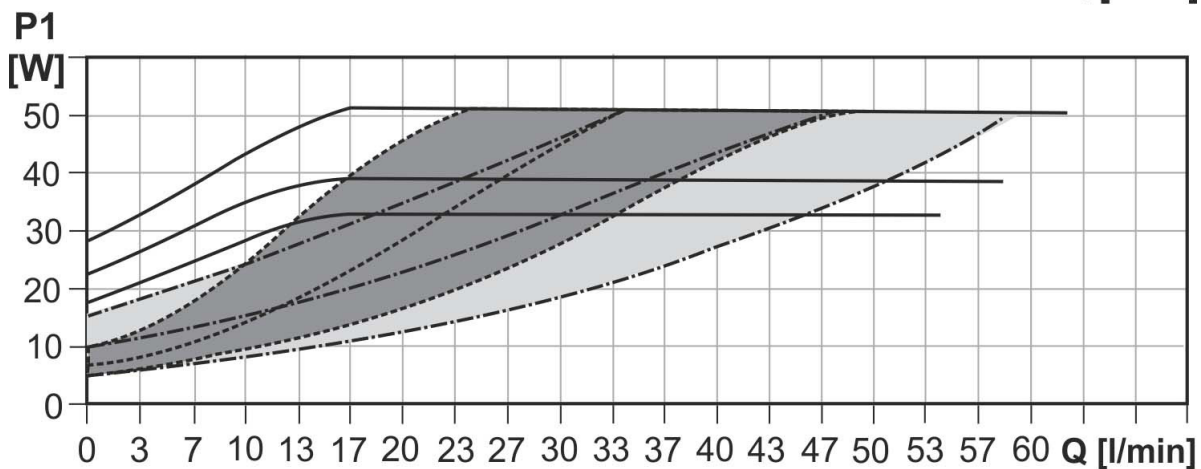
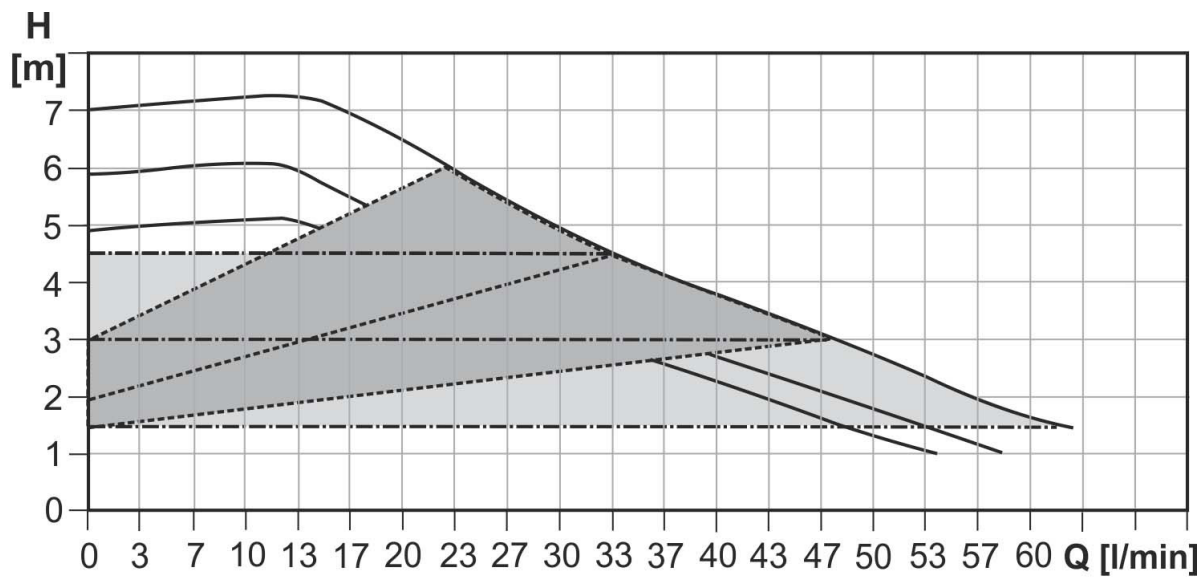

Line type	Description
—	Constant speed
- - -	Proportional pressure
- · - · -	Constant pressure

Description of Pump Profiles

a) INTERNAL CONTROL - Proportional pressure

- Head (pressure): reduced with growing system pressure drop and increased with sinking system pressure drop.



- Pump operating point: moves up or down on the selected proportional pressure curve depending on the current system pressure drop.

CONTROL MODE		DESCRIPTION
Proportional pressure	I	The lowest curve of proportional pressure
	II	The middle curve of proportional pressure
	III	The highest curve of proportional pressure
	AUTO _{ADAPT}	Automatically controls performance in the range from the highest to the lowest proportional pressure curve. AUTO _{ADAPT} mode mode is not used for solar thermal systems.

b) INTERNAL CONTROL - Constant pressure

- Head (pressure): kept constant, disregarded of the system pressure drop.
- Pump operating point: moves on the selected constant pressure curve depending on the current system pressure drop.



CONTROL MODE		DESCRIPTION
Constant pressure	I	The lowest curve of constant pressure
	II	The middle curve of constant pressure
	III	The highest curve of constant pressure
	AUTO _{ADAPT}	Automatically controls performance in the range from the highest to the lowest constant pressure curve. AUTO _{ADAPT} mode mode is not used for solar thermal systems.

c) INTERNAL CONTROL - Constant speed

- The pump runs at constant speed.
- Pump operating point: moves up or down on the selected curve depending on the current system pressure drop.



CONTROL MODE		Max. H (upper graph)	Max. P ₁ (lower graph)
Constant speed	I	5 m	33 W
	II	6 m	39 W
	III	7 m	52 W

d) EXTERNAL CONTROL - PWM C (solar)

- The pump runs up to the max. head following the constant speed curve set depending on the current PWM value.
- The speed will increase when the PWM value increases. If PWM equals 0, the pump will stop.



e) EXTERNAL CONTROL - PWM A (heating)

WARNING – IT IS PROHIBITED TO USE PWM A PUMP PROFILES

Using the PWM A (I, II, III) pump profiles in a solar pump station would cause system damage.

Settings Display

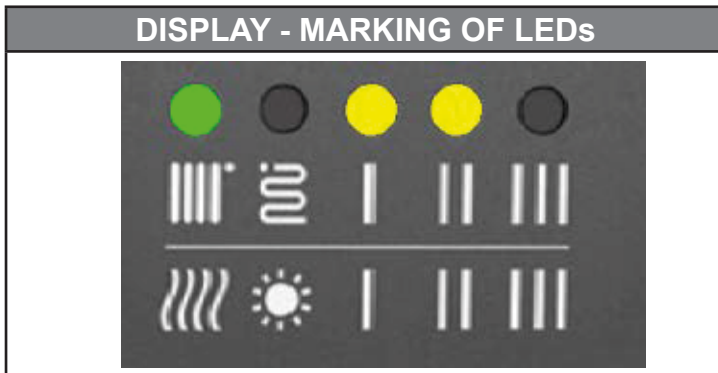

For clarity, the marking of the LEDs is further omitted.

	DISPLAY	CONTROL MODE	
	green LED NOT FLASHING	INTERNAL	
1		Proportional pressure AUTO _{ADAPT} - not used for solar thermal systems	
2		Constant pressure AUTO _{ADAPT} - not used for solar thermal systems	
3		Proportional pressure - not used for solar thermal systems	I
4			II
5			III
6		Constant pressure	I
7			II
8			III
9		Constant speed	I
10			II
11			III

	DISPLAY	CONTROL MODE	
	green LED FLASHING	EXTERNAL	
12		PWM C	
13		PWM A	I
14			II
15			III
			WARNING - DO NOT USE THESE MODES

FLASHING FREQUENCY OF GREEN LEDS	CONTROL	RECEIVING PWM SIGNAL
Not flashing	Internal	-
1 flash per second	External	NO
12 flashes per second	External	YES

WARNING: LEDs may be turned by 90° or 180°, or mirrored, depending on the specific pump type. When switched on, the pump runs at factory settings or the last setting. The display shows the current pump performance.

Setting selection

To select your desired setting, press the button repeatedly until you find the setting you need (see the table above). If you pass the desired setting, you have to go one more round until it appears again. The order of modes corresponds to the table.

Error Display

DISPLAY	CONTROL MODE
	Seized pump
	Too low power supply voltage
	Electric fault

Pump Wiring

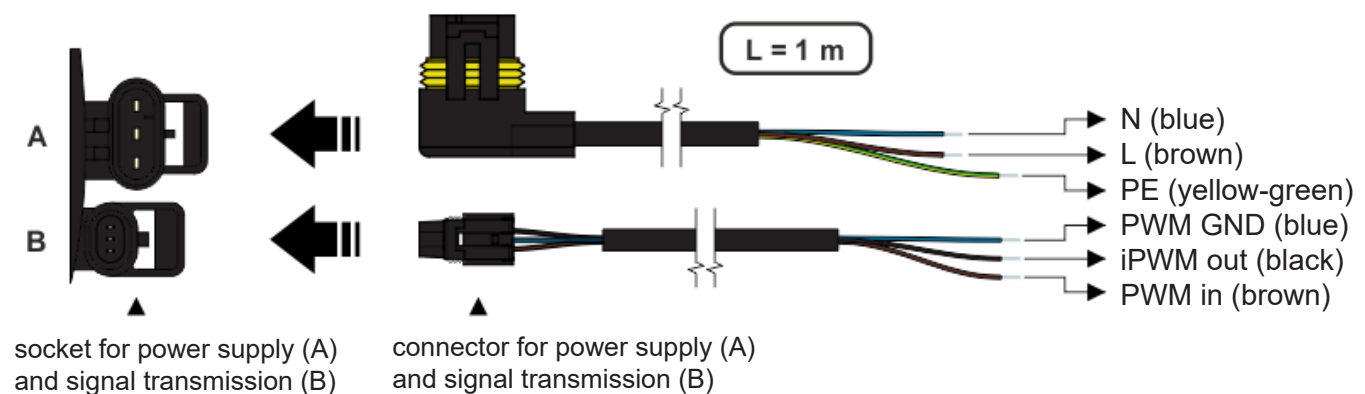

9. Filling a Solar Thermal System

For filling a solar thermal system, the ball valve above the pump must be closed and the ball valve below the pump open. The ball valve above the pump is operated by means of the enclosed spanner. Connect the filling pump to the fill and drain ball valves using hoses – see Chap. 4, and open these valves. After filling the solar thermal system, close the fill and drain ball valves, disconnect the hoses and re-open the ball valve above the pump.

Prior to commissioning the system, both the ball valves must be open!

