



PROTECTION AND CONTROL OF SOLID FUEL BOILERS



- **thermal relief valves & backup power supplies**
- **load valves & load units**
- **draft regulators**





CONTENTS

BOILER PROTECTION AGAINST OVERHEATING

TWO-WAY THERMAL RELIEF VALVES:

- 5 Insulated DBV2
Thermal Safety Relief Valves
- 6 Insulated DBV1
Thermal Relief Valves

ONE-WAY THERMAL RELIEF VALVES:

- 7 JBV1
Thermal Relief Valves
- 8 BVTS
Thermal Safety Relief Valves with capillary

BACKUP POWER SUPPLIES:

- 10 PG 500 Compact
Backup Power Supplies for circulation pumps
- 11 PG 600 S
Backup Power Supplies for circulation pumps

PROTECTION AGAINST BOILER CORROSION AND FOULING

ALL-IN-ONE UNITS

- 12 RegulusBIO
Load Units for heating systems with solid fuel boilers

LOAD UNITS:

- 15 RegulusRGMAT
Load Units with thermostatic mixing
- 27 ThermoMat
Load Units with thermostatic mixing and floating non-return valve
- 28 RegulusTOP
Load Units with electric actuated mixing

LOAD VALVES:

- 30 TSVB
Valves for return temperature control, with automatic bypass balancing
- 30 TSV
Valves for return temperature control, with manual bypass balancing

CIRCULATION PUMPS PERFORMANCE CURVES:

- 43 Grundfos
Circulation Pumps
- 44 Wilo
Circulation Pumps

BOILER OUTPUT CONTROL

- 46 RT4
Thermostatic Draft Regulators

BOILER PROTECTION AGAINST OVERHEATING

Solid fuel boilers may get overheated during operation, mostly due to a power failure. This danger can be avoided in two ways: either by **cooling the boiler via a thermostatic valve** that needs no el. energy for its operation, or by a **UPS** that supplies electric energy for the circulation pump.

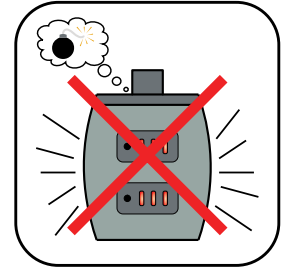

BOILER PROTECTION AGAINST FOULING AND CORROSION

During burning steam is released from the fuel. If the boiler is hot enough, the steam leaves through the chimney together with the flue gas. However, if the flue gas gets cooler on the boiler mantle, steam condensation occurs there. The condensate may contain very aggressive combustion products that cause fast corrosion and deposit formation on heat transfer surfaces (tarring).

By mixing cool return water from a heating system with hot water from the boiler flow the boiler heat transfer surfaces are kept warmer and no condensation occurs. This makes their service life significantly longer and the boiler efficiency higher.

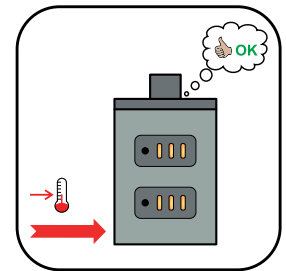

BOILER OUTPUT CONTROL

Thermostatic draft regulators keep the outgoing temperature from a solid fuel boiler at the value selected by the regulator knob. They control combustion air dampers via chains, controlling this way the boiler output. Their advantage is a robust, mechanically sturdy and thermally resistant build. Their double scale enables horizontal as well as vertical installation. They are fitted with high quality thermostatic elements made by a French manufacturer that guarantee precise operation and a long service life.

Electric controlled regulators work in the same manner, moreover they can reduce outgoing temperature from a boiler on electric signal. This way the boiler temperature and output can be controlled by a room thermostat or another electronic controller.

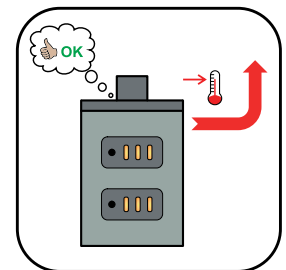

BOILER PROTECTION AGAINST OVERHEATING

Two-way Thermal Relief Valves



Insulated DBV2 Thermal Safety Relief Valve

A thermal safety relief valve designed for cooling solid-fuel boilers **with no cooling heat exchanger**. When the temperature reaches 97°C, the valve opens the cold water inlet from the mains. Cold water cools the boiler down, preventing its overheating. Hot water is discharged into sewer.

In order to work properly, the valve shall be installed in a place where the highest temperature is reached in case of overheating - usually directly in a top section of the boiler or in an outlet pipe close to the boiler.

Thermostatic elements from a renowned French manufacturer are located directly in heating water, so their **reaction to heating water temperature fluctuations is almost immediate**. The valve has a push button for manual opening (like safety valves).

TECHNICAL DATA

OPENING TEMPERATURE	97 ± 2 °C
MAX. WORKING PRESSURE - HEATING WATER	4 bar
MAX. WORKING PRESSURE - COLD WATER	6 bar
PIPE CONNECTION	G 3/4" M
HEAT SOURCE CONNECTION	R 3/4" M tapered thread
WEIGHT	0.70 kg

MODELS

MODELS	CODE
Insulated DBV2	16627
DBV2 in T-piece, 6/4" F, insulated	16863

Valve opening and closing is controlled by two independent thermostatic elements - the valve will dissipate sufficient excess heat even if one of them failed.

Functional tests are performed on each valve in production.

The valve meets the requirements set by the Pressure Equipment Directive (PED) 2014/68/EU and EN 14597. It fulfils the requirements for a device to dissipate excess heat, as of Art. 4.3.8.4, EN 303-5:2021. This is a STW device of Th type as defined by EN 14597:2012.

The valve is patented in many European countries.



DIMENSIONS

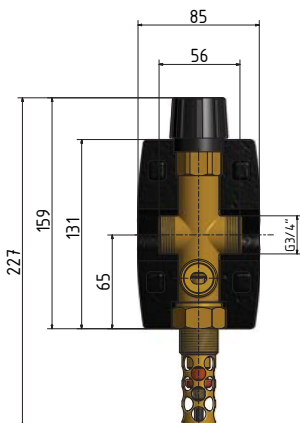

CONNECTION IN A SYSTEM

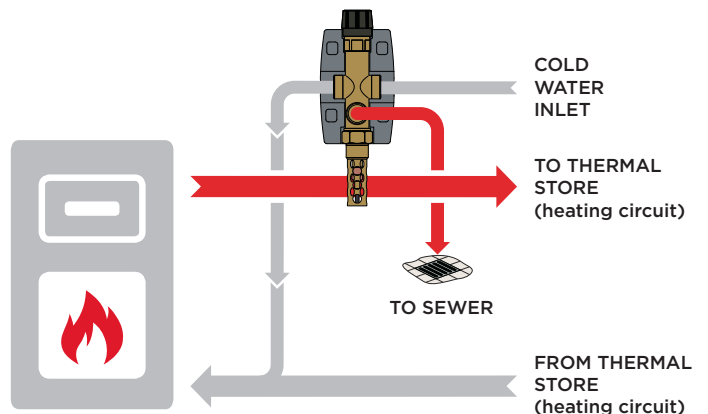

BOILER PROTECTION AGAINST OVERHEATING

Two-way Thermal Relief Valves



Insulated DBV1 Thermal Relief Valve

A thermal relief valve designed for cooling solid-fuel boilers with **no cooling heat exchanger**. When the temperature reaches 97°C, the valve opens and lets cold water in from the mains. It cools the boiler down, preventing its overheating. Hot water is discharged into a sewer.

In order to work properly, the valve shall be installed in a place where the highest temperature is reached in case of overheating - usually directly in a top section of the boiler or in an outlet pipe close to the boiler.

The thermostatic element from a renowned French manufacturer is located directly in heating water, so its **reaction to heating water temperature fluctuations is almost immediate**. The valve has a push button for manual opening (like safety valves).

Functional tests are performed on each valve in production.

TECHNICAL DATA

OPENING TEMPERATURE	97 ± 2 °C
MAX. WORKING PRESSURE - HEATING WATER	4 bar
MAX. WORKING PRESSURE - COLD WATER	6 bar
PIPE CONNECTION	G 3/4" M
HEAT SOURCE CONNECTION	R 3/4" M tapered thread
WEIGHT	0.70 kg

MODELS

MODELS	CODE
Insulated DBV1	16912
DBV1 in T-piece, 6/4" F, insulated	16913

The valve is patented in many European countries.

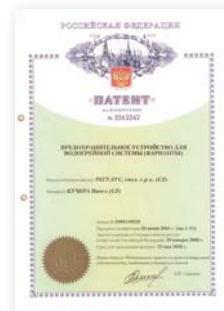

DIMENSIONS

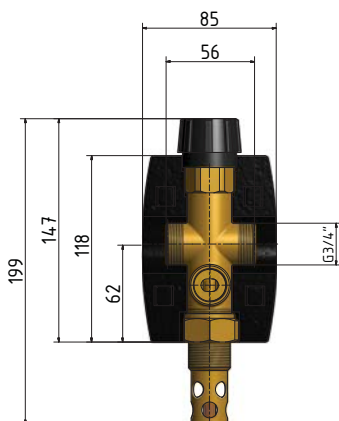

CONNECTION IN A SYSTEM

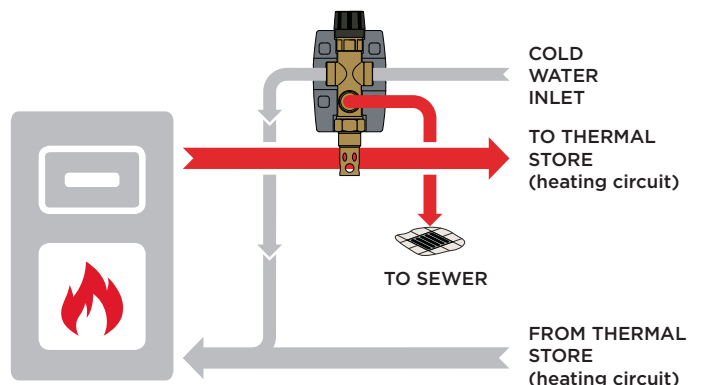

BOILER PROTECTION AGAINST OVERHEATING

One-way Thermal Relief Valves



JBV1 Thermal Relief Valve

A thermal relief valve designed for cooling solid-fuel boilers **with a cooling heat exchanger**. When the temperature reaches 97°C, the valve opens and lets cold water in from the mains. **It cools the boiler down via the cooling heat exchanger**, preventing its overheating. Hot water is discharged into a sewer.

In order to work properly, the valve shall be installed in a place where the highest temperature is reached in case of overheating - usually directly in a top section of the boiler or in an outlet pipe close to the boiler.

The thermostatic element from a renowned French manufacturer is located directly in heating water, so **its reaction to heating water temperature fluctuations is almost immediate**. As the valve has no capillary, it cannot be damaged during installation. The valve has a push button for manual opening (like safety valves).

Functional tests are performed on each valve in production.

TECHNICAL DATA

OPENING TEMPERATURE	97 ± 2 °C
MAX. WORKING PRESSURE - HEATING WATER	4 bar
MAX. WORKING PRESSURE - COLD WATER	6 bar
PIPE CONNECTION	G 3/4" M
HEAT SOURCE CONNECTION	G 1/2" M
WEIGHT	0.70 kg
CODE	8877

The valve is patented in many European countries.



DIMENSIONS

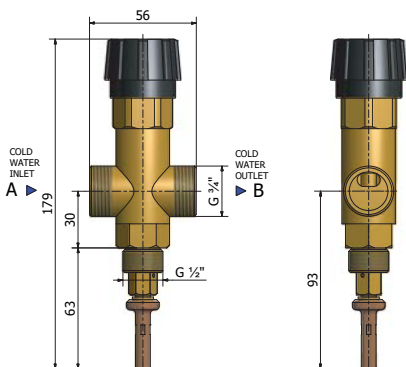

CONNECTION IN A SYSTEM

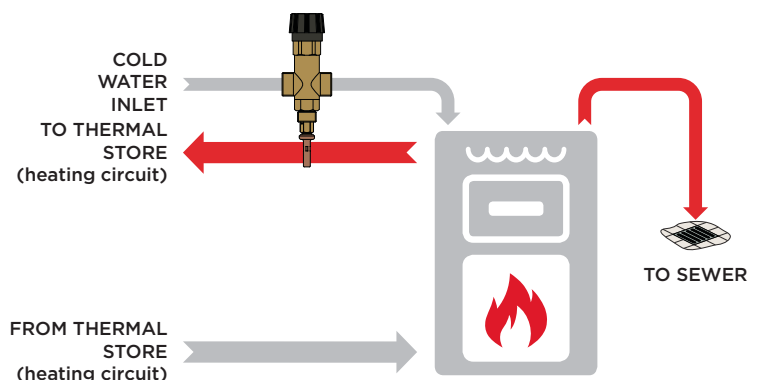

BOILER PROTECTION AGAINST OVERHEATING

One-way Thermal Relief Valves



BVTS

Thermal Safety Relief Valves with capillary

Thermostatic valve with a capillary designed for cooling solid-fuel boilers with **a cooling heat exchanger**.

By opening a cold water inlet, the valve removes heat from a boiler cooling heat exchanger, protecting the boiler from overheating in case of emergency. Its opening temperature depends on the valve version (the valve is factory set and cannot be changed by the user).

In order to work properly, the valve sensor shall be installed in a place where the highest temperature is reached in case of overheating - usually directly in a top section of the boiler or in an outlet pipe close to the boiler.

The valve has an activation push button for manual opening. Functional tests are performed on each valve in production.

TECHNICAL DATA

MAX. WORKING PRESSURE - HEATING WATER	6 bar
MAX. WORKING PRESSURE - COLD WATER	10 bar
CONNECTION THREAD	G 3/4" F
SENSOR SHEATH THREAD	G 1/2" M

The valve meets the requirements set by the Pressure Equipment Directive (PED) 2014/68/EU and EN 14597:2012. It is a STW device of Th type as defined by EN 14597:2012, so it fulfils the requirements for a device to dissipate excess heat, as of Art. 4.3.8.4, EN 303-5:2021.

DIMENSIONS

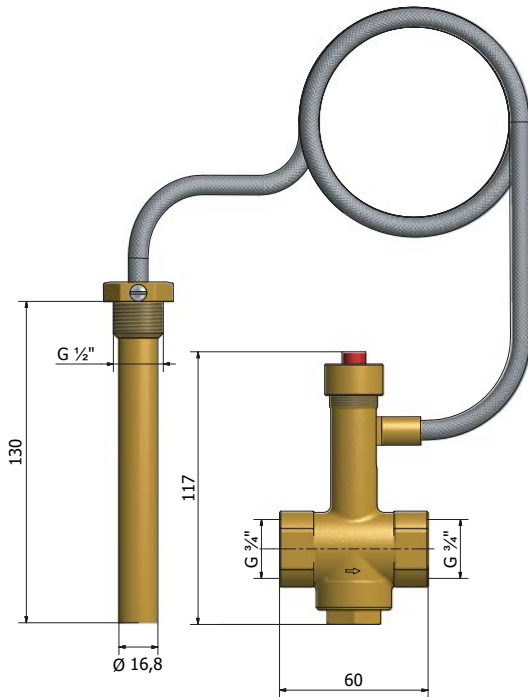

CONNECTION IN A SYSTEM

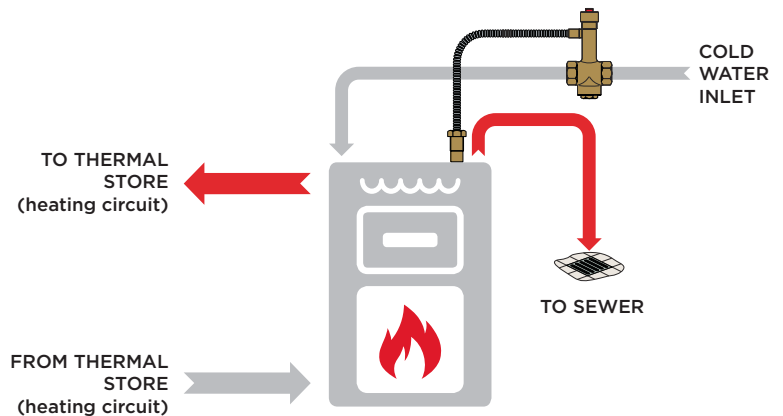

MODELS	CAPILLARY LENGTH [MM]	CAPILLARY DESIGN	VALVE OPENING TEMP. T ± 2 °C [°C]	WEIGHT [KG]	CODE
BVTS 97°C 1.3M NIKL	1 300	fixed	97	0.7	14713
BVTS 50°C 1.3M O	1 300	detachable	50	0.7	14473
BVTS 55°C 1.3M	1 300	fixed	55	0.7	14474
BVTS 65°C 1.3M	1 300	fixed	65	0.7	14475
BVTS 70°C 1.3M	1 300	fixed	70	0.7	14476
BVTS 95°C 1.3M	1 300	fixed	95	0.7	14477
BVTS 95°C 4.0M	4 000	fixed	95	1.0	14478
BVTS 95°C 1.3M O	1 300	detachable	95	0.7	14479
BVTS 97°C 1.3M	1 300	fixed	97	0.7	14480
BVTS 100°C 1.3M O	1 300	detachable	100	0.7	14481
BVTS 108°C 1.3M	1 300	fixed	108	0.7	14483



Version with a detachable capillary



Nickel-plated version



4-m capillary version

BOILER PROTECTION AGAINST OVERHEATING

Backup Power Supplies



PG 500 Compact Backup Power Supply with integrated batteries for circulation pumps

Backup power supply for circulation pumps or other electric equipment during power cuts. It will provide power supply for a boiler circulation pump, preventing the boiler overheating.

Features

- Automatic switching from grid to battery and vice versa
- High efficiency inverter
- Smart two-step battery charging with overcharge protection
- Protection from overload and complete battery discharge
- Multi-function LED and sound signals
- No fan, thus very quiet operation

TECHNICAL DATA

NOMINAL VOLTAGE	230 V 50 Hz
INPUT VOLTAGE RANGE	170 - 260 V 50 Hz
OUTPUT WAVE FORM	modified sine wave
OPERATING CONDITIONS	0 - 40 °C, non-condensing humidity
NO. OF BATTERIES	2
BATTERY CAPACITY	18 Ah (2 x 9 Ah) / 12 V
MAX. INVERTER OUTPUT POWER	600 W
CODE	16214

This Backup Power Supply comes with two maintenance-free 12V, 9Ah batteries. Service life of the batteries is about 5 years. The real service life depends on operating conditions. Batteries are delivered charged, so they should not be stored for more than 4 months after leaving Regulus's warehouse. They need to get charged after that period.

BACKUP TIMES

PG 500 Compact

POWER CONSUMPTION OF THE LOAD	20 W	45 W
BACKUP TIME	5 h	3h 30 min



BOILER PROTECTION AGAINST OVERHEATING Backup Power Supplies



PG 600 S

Backup Power Supplies for circulation pumps, smooth output sine wave

Backup power supply for circulation pumps or other electric equipment during power cuts. It will provide power supply for a boiler circulation pump, preventing the boiler overheating.

Features

- Automatic switching from grid to battery and vice versa, adjustable charging current
- High efficiency inverter
- Smart three-step battery charging with overcharge protection
- Protection from overload and complete battery discharge, possibility to set the minimum battery voltage for power supply is disconnection
- LCD display
- Internal temperature controlled fan
- Smooth output sine wave

TECHNICAL DATA

NOMINAL VOLTAGE	230 V, 50 Hz
INPUT VOLTAGE RANGE	140 ~ 280 V +/- 5%, 50 Hz +/- 5 Hz
OUTPUT WAVE FORM	smooth sine wave
OPERATING CONDITIONS	0 - 40 °C, non-condensing humidity

Backup Power Supplies come with special maintenance-free batteries. Service life of the batteries is about 10 years. The real service life depends on operating conditions. Batteries are delivered charged, so they should not be stored for more than 4 months after leaving Regulus's warehouse. They need to get charged after that period.

MODELS

	PG 600 S	PG 600 S-18	PG 600 S-44	PG 600 S-100
NO. OF BATTERIES	0	1	1	1
BATTERY CAPACITY	-	18 Ah/12V	44 Ah/12V	100 Ah/12V
MAX. INVERTER OUTPUT POWER	600 W	600 W	600 W	600 W
CODE	17035	17135	17136	17137

BACKUP TIMES

	PG 600 S-18		PG 600 S-44		PG 600 S-100	
POWER CONSUMPTION OF THE LOAD	20 W	45 W	65 W	100 W	120 W	250 W
BACKUP TIME	3h 11 min	2h 02 min	3h 35 min	2h 26 min	4h 37 min	2h 31 min



ALL-IN-ONE UNITS

RegulusBIO Load Units

RegulusBIO 55 MIX W-PWM 1F TRS6K Load Unit for heating system with solid fuel (biomass) boiler, thermal store and integrated system controller



RegulusBIO 55 MIX W-PWM 1F TRS6K Load Unit is designed for heating systems with a solid fuel boiler with a thermal store, with the possibility of DHW heating. Water to the heating system is mixed by the three-way mixing valve with motorised actuator, the temperature of the return water to the boiler is kept at the minimum temperature of 55° C by the load valve. Excess boiler output is stored in the thermal store, from where it is automatically drawn after the boiler goes out.

An integrated weather compensated controller controls the operation of the whole system. The load unit is completely internally wired and equipped with a power cable with a plug. The system can be controlled by a room unit with a touch screen (to be ordered separately), or with a WiFi connection and Internet access via a mobile phone application.

COMPONENTS

- Heating system pump
- Boiler pump
- TSV3B Load Valve
- 3-way mixing valve for heating system
- Mixing valve actuator
- TRS6 K Weather Compensated Controller
- Mains power cord and complete electrical wiring of the entire load unit
- 2 ball valves and 2 drain valves for shutting off and draining the heating system
- 2 ball valves for shutting off the thermal store connecting pipes (enclosed)
- 2 ball valves to shut off boiler
- 4 thermometers

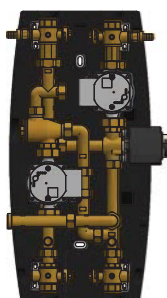

TECHNICAL DATA

CONNECTIONS	1" F
FLUID WORKING TEMPERATURE	5 - 95 °C
NOMINAL TEMPERATURE AT BOILER INLET	55 °C
POWER SUPPLY	230 V, 50 Hz
PIPE PITCH	125 mm
DIMENSIONS	640 x 250 x 350 mm
PUMP	Wilo Para 25/8 iPWM1
PUMP CONTROL	PWM1 (heating) + flowrate info
MAX. HEAD	8.4 m
MAX. BOILER OUTPUT	40 kW
CODE	17499

Possible variants on order:

- connections: 3/4", 5/4", Cu22, Cu28
- return water temperatures: 45, 50, 60, 65, 70 °C
- safety valve in range 1.5-6 bar

CONNECTION IN A SYSTEM

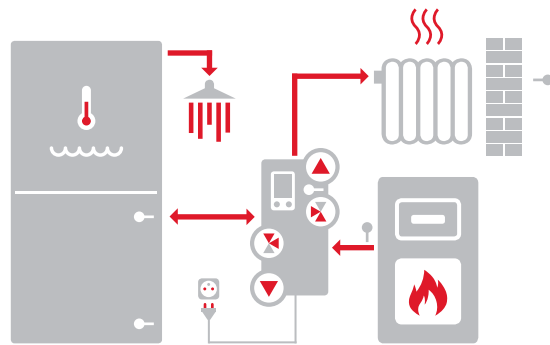

ACCESSORIES

Room temperature sensor

Code: 16167

MAGNET FILTERBALL

1" Ball valve with filter & magnet

Code: 17405

Digital room unit with touch screen

Code: 17150

Digital room unit with a touch screen
and Internet connection via WiFi

Code: 18126

ALL-IN-ONE UNITS

RegulusBIO Load Units

RegulusBIO 55 MIX-BP G75 1F Load Unit for heating system with solid fuel (biomass) boiler and thermal store



RegulusBIO 55 MIX-BP G75 1F Load Unit is designed for heating systems with a solid fuel boiler with a thermal store, with the possibility of DHW heating. Water to the heating system is mixed by a three-way mixing valve, the temperature of the return water to the boiler is kept at a minimum temperature of 55° C by a load valve.

Excess boiler output is stored in the thermal store. The heating output is controlled by an external controller by controlling the actuated mixing valve. The actuator and controller are not included in supply.

TECHNICAL DATA

CONNECTIONS	1" F
FLUID WORKING TEMPERATURE	5 - 95 °C
NOMINAL TEMPERATURE AT BOILER INLET	55 °C
POWER SUPPLY	230 V, 50 Hz
PIPE PITCH	125 mm
DIMENSIONS	640 x 250 x 350 mm
PUMP	Grundfos UPM3 25-75
PUMP CONTROL	ON/OFF (I, II, III) or PWM-A (heating)
MAX. HEAD	7.5 m
MAX. BOILER OUTPUT	38 kW
CODE	17553

Possible variants on order:

- connections: 3/4", 5/4", Cu22, Cu28
- return water temperatures: 45, 50, 60, 65, 70 °C
- safety valve in range 1.5-6 bar
- mixing valve actuator, optionally adjustable to a constant temperature or with weather compensation control

COMPONENTS

- Heating system pump incl. power cable
- Boiler system pump incl. power cable
- TSV3B Load Valve
- 3-way mixing valve for heating system
- 2 ball valves and 2 drain valves for shutting off and draining the heating system
- 2 ball valves for shutting off the thermal store connecting pipes (enclosed)
- 2 ball valves to shut off boiler
- 4 thermometers

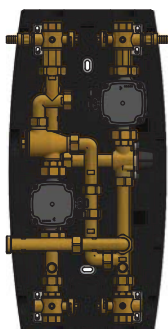

CONNECTION IN A SYSTEM

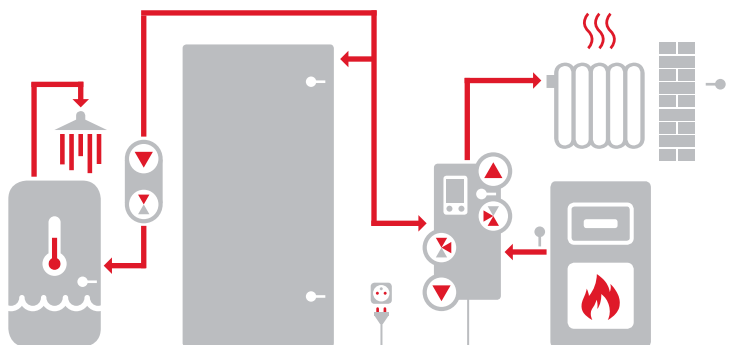
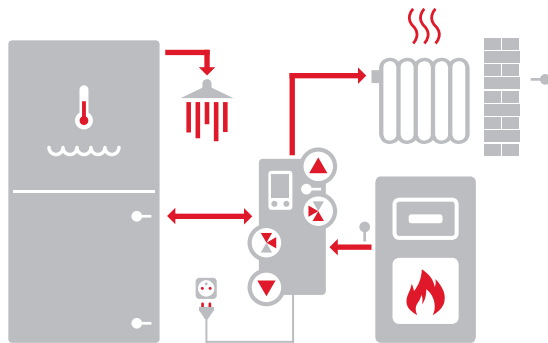

ALL-IN-ONE UNITS

RegulusBIO Load Units

RegulusBIO 55 G75 1F Load Unit for heating system with solid fuel (biomass) boiler



RegulusBIO 55 G 1F Load Unit is designed for solid fuel boilers without a thermal store, with the possibility of DHW heating. Water to the heating system is mixed to a temperature corresponding to the boiler output. The temperature of the return water to the boiler is kept at the minimum temperature of 55° C by the load valve. Excess boiler output is stored in the thermal store, from where it is automatically drawn after the boiler goes out. The heating output is controlled by controlling the boiler output – e.g. by switching a pellet fired boiler.

TECHNICAL DATA

CONNECTIONS	1" F
FLUID WORKING TEMPERATURE	5 - 95 °C
NOMINAL TEMPERATURE AT BOILER INLET	55 °C
POWER SUPPLY	230 V, 50 Hz
PIPE PITCH	125 mm
DIMENSIONS	640 x 250 x 350 mm
PUMP	Grundfos UPM3 25-75
PUMP CONTROL	ON/OFF (I, II, III) or PWM-A (heating)
MAX. HEAD	7.5 m
MAX. BOILER OUTPUT	38 kW
CODE	17502

Possible variants on order:

- connections: 3/4", 5/4", Cu22, Cu28
- return water temperatures: 45, 50, 60, 65, 70 °C
- safety valve in range 1.5-6 bar

COMPONENTS

- Heating system pump incl. power cable
- Boiler system pump incl. power cable
- TSV3B Load Valve
- 2 ball valves and 2 drain valves for shutting off and draining the heating system
- 2 ball valves for shutting off the thermal store connecting pipes (enclosed)
- 2 ball valves to shut off boiler
- 4 thermometers

CONNECTION IN A SYSTEM

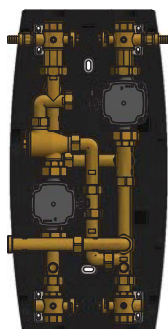
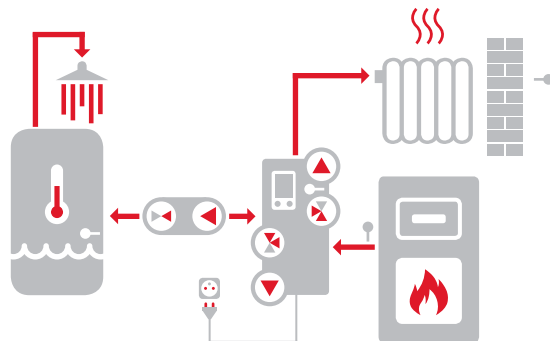

PROTECTION AGAINST BOILER CORROSION AND FOULING

RegulusRGMAT Load Units



RGMAT E W6 KK

RegulusRGMAT Load Unit with thermostatic mixing, with ball valves

RegulusRGMAT Load unit for solid-fuel boilers and fireplaces that **prevents low-temperature corrosion and boiler fouling by keeping a boiler (fireplace) inlet temperature** through a load valve.

The unit is completed with a set of three fittings with ball valves to facilitate the repair or disassembly of individual components without draining the system. RegulusRGMAT load unit comes in a left-hand version (outlet to boiler is on its left side), and can be easily modified to a right-hand version (outlet to boiler on its right side) during installation. Its installation position can be either horizontal or vertical.

RGMAT E W6 KK consists of a Wilo PARA 25/6 SC high efficiency circulation pump incl. connection cable, 3 shutoff ball valves for inlets and outlet, thermometer, insulation and TSV5BMF valve with a thermostatic element of 55 and 65 °C opening temperature.

TECHNICAL DATA

FLUID WORKING TEMPERATURE	5 - 95 °C
POWER SUPPLY	230 V, 50 Hz
IP RATING	IP44
TOTAL WEIGHT	4,2kg
CONNECTIONS	3 x G1" F
K_{vs} from A to AB	7.0 m ³ /h
K_{vs} from B to AB	6.0 m ³ /h
MAX. HEAD	6.7m
PUMP OPERATING POINTS at Δt 20 K	1.7 m ³ /h flow rate 3.9m head
PUMP CONTROL	ON/OFF (Δp -c / Δp -v / I, II, III)

Prevention of low-temperature corrosion of boilers. Installation possible with A inlet from either right or left side. Minimum heat loss thanks to thermal insulation.

VERSIONS	CODE	VALVE OPENING TEMPERAT.	RECOMMENDED MAX. BOILER OUTPUT
RGMAT E 55 W6 KK	19015	55 °C	45 kW
RGMAT E 65 W6 KK	19016	65 °C	32 kW

CONNECTION IN A SYSTEM

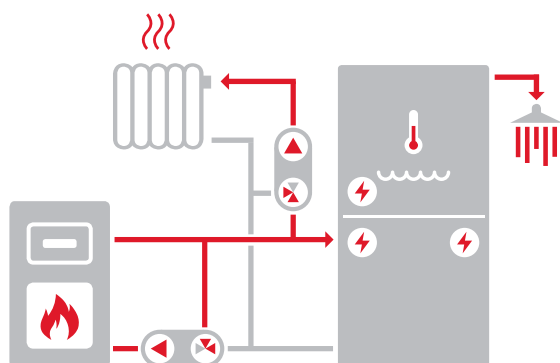

DIMENSIONS

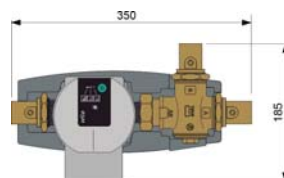

PROTECTION AGAINST BOILER CORROSION AND FOULING

RegulusRGMAT Load Units



RGMAT E W8 5/4 KK

RegulusRGMAT Load Unit with thermostatic mixing, with ball valves

RegulusRGMAT Load unit for solid-fuel boilers and fireplaces that **prevents low-temperature corrosion and boiler fouling by keeping a boiler (fireplace) inlet temperature** through a load valve.

The unit is completed with a set of three fittings with ball valves to facilitate the repair or disassembly of individual components without draining the system. RegulusRGMAT load unit comes in a left-hand version (outlet to boiler is on its left side), and can be easily modified to a right-hand version (outlet to boiler on its right side) during installation. Its installation position can be either horizontal or vertical.

RGMAT E W8 5/4 KK consists of a Wilo PARA 25/8 SC high efficiency circulation pump incl. connection cable, 3 shutoff ball valves for inlets and outlet, thermometer, insulation and TSV5B-MF valve with a thermostatic element of 55 and 65 °C opening temperature.

TECHNICAL DATA

FLUID WORKING TEMPERATURE	5 - 95 °C
POWER SUPPLY	230 V, 50 Hz
IP RATING	IP44
TOTAL WEIGHT	4.6 kg
CONNECTIONS	3 x G5/4" F
K_{vs} from A to AB	7.0 m ³ /h
K_{vs} from B to AB	6.0 m ³ /h
MAX. HEAD	8.5 m
PUMP OPERATING POINTS at Δt 20 K	2.6 m ³ /h flow rate 4.6 m head
PUMP CONTROL	ON/OFF (Δp -c / Δp -v / I, II, III)

Prevention of low-temperature corrosion of boilers. Installation possible with A inlet from either right or left side. Minimum heat loss thanks to thermal insulation.

VERSIONS	CODE	VALVE OPENING TEMPERAT.	RECOMMENDED MAX. BOILER OUTPUT
RGMAT E 55 W8 5/4 KK	18654	55 °C	59 kW
RGMAT E 65 W8 5/4 KK	18657	65 °C	43 kW

CONNECTION IN A SYSTEM

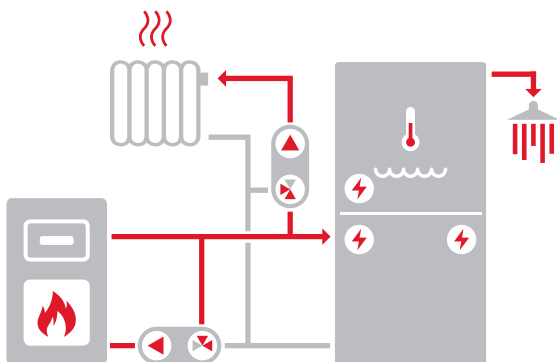

DIMENSIONS

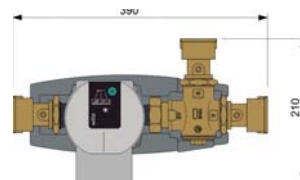

PROTECTION AGAINST BOILER CORROSION AND FOULING RegulusRGMAT Load Units



RGMAT E G75 5/4 KK

RegulusRGMAT Load Unit with thermostatic mixing, with ball valves

RegulusRGMAT Load unit for solid-fuel boilers and fireplaces that **prevents low-temperature corrosion and boiler fouling by keeping a boiler (fireplace) inlet temperature** through a load valve.

The unit is completed with a set of three fittings with ball valves to facilitate the repair or disassembly of individual components without draining the system. RegulusRGMAT load unit comes in a left-hand version (outlet to boiler is on its left side), and can be easily modified to a right-hand version (outlet to boiler on its right side) during installation. Its installation position can be either horizontal or vertical.

RGMAT E G75 5/4 consists of a Grundfos UPM3 25-75 high efficiency circulation pump incl. connection cable, 3 shutoff ball valves for inlets and outlet, thermometer, insulation and TSV5BMF valve with a thermostatic element of 55 and 65 °C opening temperature.

TECHNICAL DATA

FLUID WORKING TEMPERATURE	5 - 95 °C
POWER SUPPLY	230 V, 50 Hz
IP RATING	IP44
TOTAL WEIGHT	4.4 kg
CONNECTIONS	3 x G5/4" F
K_{vs} from A to AB	7.0 m ³ /h
K_{vs} from B to AB	6.0 m ³ /h
MAX. HEAD	7.5 m
PUMP OPERATING POINTS at Δt 20 K	2.5 m ³ /h flow rate 4.2m head
PUMP CONTROL	ON/OFF (Δp -c / Δp -v / I, II, III)

Prevention of low-temperature corrosion of boilers. Installation possible with A inlet from either right or left side. Minimum heat loss thanks to thermal insulation.

VERSIONS	CODE	VALVE OPENING TEMPERAT.	RECOMMENDED MAX. BOILER OUTPUT
RGMAT E 55 G75 5/4 KK	18985	55 °C	57 kW
RGMAT E 65 G75 5/4 KK	18986	65 °C	41 kW

CONNECTION IN A SYSTEM

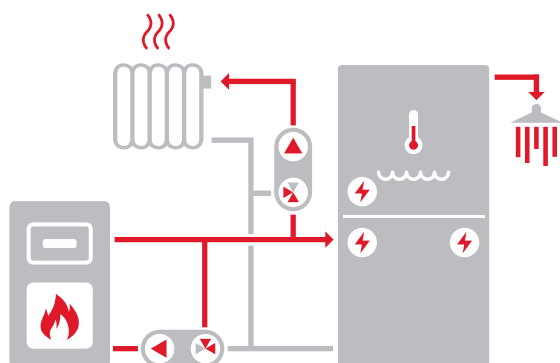

DIMENSIONS

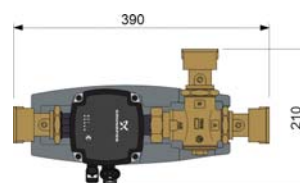

PROTECTION AGAINST BOILER CORROSION AND FOULING

RegulusRGMAT Load Units



RGMAT E G60

RegulusRGMAT Load Unit with thermostatic mixing

RegulusRGMAT Load unit for solid-fuel boilers and fireplaces that **prevents low-temperature corrosion and boiler fouling by keeping a boiler (fireplace) inlet temperature** through a load valve.

RegulusRGMAT load unit comes in a left-hand version (outlet to boiler is on its left side), and can be easily modified to a right-hand version (outlet to boiler on its right side) during installation. Its installation position can be either horizontal or vertical.

RGMAT E G60 consists of a Grundfos UPM3 FLEX AS 25-60 high efficiency circulation pump incl. connection cable, shut-off ball valve for the pump, thermometer, insulation and TSV3BF valve with a thermostatic element of 45 to 70 °C opening temperature.

TECHNICAL DATA

FLUID WORKING TEMPERATURE	5 - 95 °C
POWER SUPPLY	230 V, 50 Hz
IP RATING	IP44
TOTAL WEIGHT	3.25 kg
CONNECTIONS	3 x G1" F
K_{vs} from A to AB	6.2 m ³ /h
K_{vs} from B to AB	4.4 m ³ /h
MAX. HEAD	6 m
PUMP OPERATING POINTS at Δt 20 K	1.7 m ³ /h flow rate 4.2 m head
PUMP CONTROL	ON/OFF (Δp -c / Δp -v / I, II, III)

Prevention of low-temperature corrosion of boilers. Installation possible with A inlet from either right or left side. Minimum heat loss thanks to thermal insulation.

VERSIONS	CODE	VALVE OPENING TEMPERAT.	RECOMMENDED MAX. BOILER OUTPUT
RGMAT E 45 G60	19083	45 °C	46 kW
RGMAT E 50 G60	19090	50 °C	42 kW
RGMAT E 55 G60	19086	55 °C	36 kW
RGMAT E 60 G60	19092	60 °C	32 kW
RGMAT E 65 G60	19089	65 °C	26 kW
RGMAT E 70 G60	19091	70 °C	22 kW

CONNECTION IN A SYSTEM

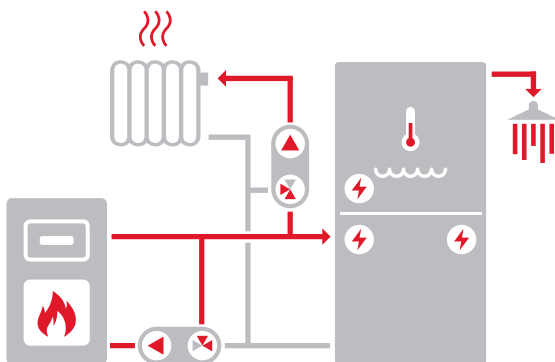

DIMENSIONS

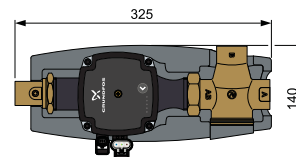

PROTECTION AGAINST BOILER CORROSION AND FOULING

RegulusRGMAT Load Units



RGMAT E G75 5/4

RegulusRGMAT Load Unit with thermostatic mixing

RegulusRGMAT Load unit for solid-fuel boilers and fireplaces that **prevents low-temperature corrosion and boiler fouling by keeping a boiler (fireplace) inlet temperature** through a load valve.

RegulusRGMAT load unit comes in a left-hand version (outlet to boiler is on its left side), and can be easily modified to a right-hand version (outlet to boiler on its right side) during installation. Its installation position can be either horizontal or vertical.

RGMAT E G75 5/4 consists of a Grundfos UPM3 FLEX AS 25-75 high efficiency circulation pump incl. connection cable, thermometer, insulation and TSV5B valve with a thermostatic element of 55 and 65 °C opening temperature. 70 °C.

TECHNICAL DATA

FLUID WORKING TEMPERATURE	5 - 95 °C
POWER SUPPLY	230 V, 50 Hz
IP RATING	IP44
TOTAL WEIGHT	3.7 kg
CONNECTIONS	3 x G5/4" F
K_{vs} from A to AB	7.0 m ³ /h
K_{vs} from B to AB	4.9 m ³ /h
MAX. HEAD	7.5 m
PUMP OPERATING POINTS at Δt 20 K	2.5 m ³ /h flow rate 4.2 m head
PUMP CONTROL	ON/OFF (Δp -c / Δp -v / I, II, III)

Prevention of low-temperature corrosion of boilers. Installation possible with A inlet from either right or left side. Minimum heat loss thanks to thermal insulation.

VERSIONS	CODE	VALVE OPENING TEMPERAT.	RECOMMENDED MAX. BOILER OUTPUT
RGMAT E 55 G75 5/4	16395	55 °C	53 kW
RGMAT E 65 G75 5/4	16397	65 °C	38 kW

CONNECTION IN A SYSTEM

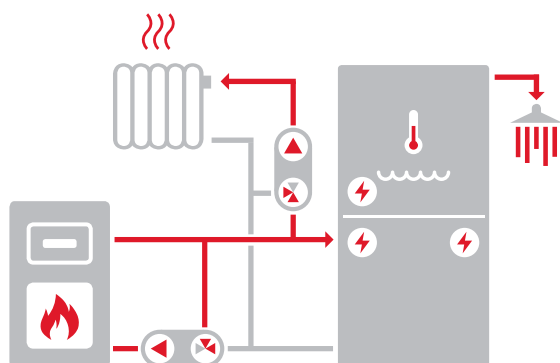

DIMENSIONS

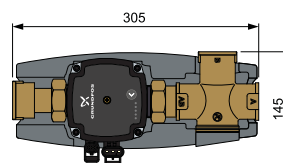

PROTECTION AGAINST BOILER CORROSION AND FOULING

RegulusRGMAT Load Units



RGMAT E W6

RegulusRGMAT Load Unit with thermostatic mixing

RegulusRGMAT Load unit for solid-fuel boilers and fireplaces that **prevents low-temperature corrosion and boiler fouling by keeping a boiler (fireplace) inlet temperature** through a load valve.

RegulusRGMAT load unit comes in a left-hand version (outlet to boiler is on its left side), and can be easily modified to a right-hand version (outlet to boiler on its right side) during installation. Its installation position can be either horizontal or vertical.

RGMAT E W6 consists of a Wilo PARA 25/6 SC high efficiency circulation pump incl. connection cable, shut-off ball valve for the pump, thermometer, insulation and TSV3BF valve with a thermostatic element of 45 to 70°C opening temperature.

TECHNICAL DATA

FLUID WORKING TEMPERATURE	5 - 95 °C
POWER SUPPLY	230 V, 50 Hz
IP RATING	IP44
TOTAL WEIGHT	3.3 kg
CONNECTIONS	3x G1" F
K_{vs} from A to AB	6.2 m ³ /h
K_{vs} from B to AB	4.4 m ³ /h
MAX. HEAD	6.7 m
PUMP OPERATING POINTS at Δt 20 K	1.7 m ³ /h flow rate 3.9 m head
PUMP CONTROL	ON/OFF (Δp -c / Δp -v / I, II, III)

Prevention of low-temperature corrosion of boilers. Installation possible with A inlet from either right or left side. Minimum heat loss thanks to thermal insulation.

VERSIONS	CODE	VALVE OPENING TEMPERAT.	RECOMMENDED MAX. BOILER OUTPUT
RGMAT E 45 W6	18668	45 °C	45 kW
RGMAT E 50 W6	18680	50 °C	42 kW
RGMAT E 55 W6	18612	55 °C	36 kW
RGMAT E 60 W6	18681	60 °C	32 kW
RGMAT E 65 W6	18682	65 °C	26 kW
RGMAT E 70 W6	18683	70 °C	22 kW

CONNECTION IN A SYSTEM

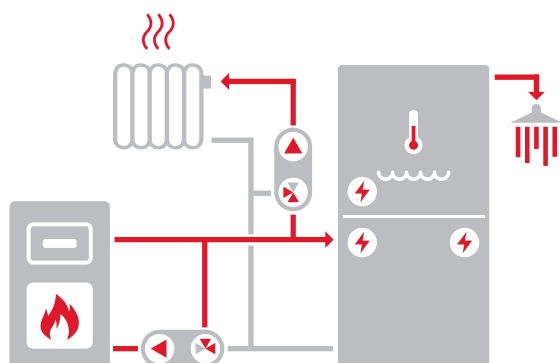

DIMENSIONS

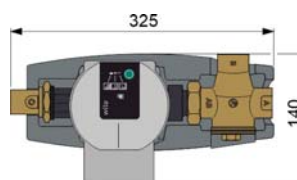

Also available with PARA 25/8 iPWM1 pump controlled by PWM signal
Code: 18133 - 55°C, 18131 - 65 °C.

PROTECTION AGAINST BOILER CORROSION AND FOULING

RegulusRGMAT Load Units



RGMAT E W8 5/4

RegulusRGMAT Load Unit with thermostatic mixing

RegulusRGMAT Load unit for solid-fuel boilers and fireplaces that **prevents low-temperature corrosion and boiler fouling by keeping a boiler (fireplace) inlet temperature** through a load valve.

RegulusRGMAT load unit comes in a left-hand version (outlet to boiler is on its left side), and can be easily modified to a right-hand version (outlet to boiler on its right side) during installation. Its installation position can be either horizontal or vertical.

RGMAT E W8 5/4 consists of a Wilo PARA 25/8 SC high efficiency circulation pump incl. connection cable, thermometer, insulation and TSV5B valve with a thermostatic element of 55 and 65°C opening temperature.

TECHNICAL DATA

FLUID WORKING TEMPERATURE	5 - 95 °C
POWER SUPPLY	230 V, 50 Hz
IP RATING	IP44
TOTAL WEIGHT	3.7 kg
CONNECTIONS	3x G5/4" F
K_{vs} from A to AB	7.0 m ³ /h
K_{vs} from B to AB	4.9 m ³ /h
MAX. HEAD	8.5 m
PUMP OPERATING POINTS at Δt 20 K	2.6 m ³ /h flow rate 4.6 m head
PUMP CONTROL	ON/OFF (Δp -c / Δp -v / I, II, III)

Prevention of low-temperature corrosion of boilers. Installation possible with A inlet from either right or left side. Minimum heat loss thanks to thermal insulation.

VERSIONS	CODE	VALVE OPENING TEMPERAT.	RECOMMENDED MAX. BOILER OUTPUT
RGMAT E 55 W8 5/4	18684	55 °C	55 kW
RGMAT E 65 W8 5/4	18663	65 °C	40 kW

CONNECTION IN A SYSTEM

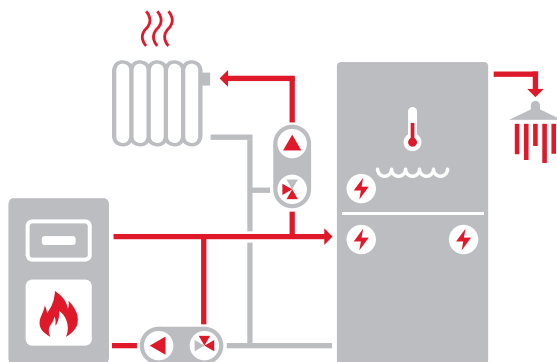

DIMENSIONS

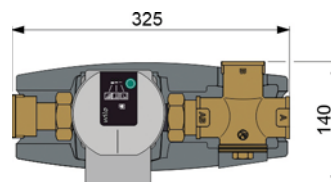

PROTECTION AGAINST BOILER CORROSION AND FOULING

RegulusRGMAT Load Units



RGMAT EA G60

RegulusRGMAT Load Unit with thermostatic mixing and manual bypass balancing

RegulusRGMAT Load unit for solid-fuel boilers and fireplaces that **prevents low-temperature corrosion and boiler fouling by keeping a boiler (fireplace) inlet temperature** through a load valve.

RegulusRGMAT load unit comes in a left-hand version (outlet to boiler is on its left side), and can be easily modified to a right-hand version (outlet to boiler on its right side) during installation. Its installation position can be either horizontal or vertical.

RGMAT EA G60 consists of a Grundfos UPM3 FLEX AS 25-60 high efficiency circulation pump incl. connection cable, shut-off ball valve for the pump, thermometer, insulation and TSV3 valve with a thermostatic element of 65 or 72°C opening temperature. **Balancing of TSV valve needs to be performed manually using a balancing valve in the bypass pipe.**

Boiler manufacturer ATMOS recommends that these models of load units are used with his boilers.

TECHNICAL DATA

FLUID WORKING TEMPERATURE	5 - 95 °C
POWER SUPPLY	230 V, 50 Hz
IP RATING	IP44
TOTAL WEIGHT	3.25 kg
CONNECTIONS	3 x 1" F
K_{vs} from A to AB	6.2 m ³ /h
K_{vs} from B to AB	10.1 m ³ /h
MAX. HEAD	6 m
PUMP OPERATING POINTS at Δt 20 K	1.7 m ³ /h flow rate 4.2 m head
PUMP CONTROL	ON/OFF (Δp -c / Δp -v / I, II, III)

Prevention of low-temperature corrosion of boilers. Installation possible with A inlet from either right or left side. Minimum heat loss thanks to thermal insulation.

VERSIONS	CODE	VALVE OPENING TEMPERAT.	RECOMMENDED MAX. BOILER OUTPUT
RGMAT EA 65 G60	19084	65 °C	25 kW
RGMAT EA 72 G60	19087	72 °C	25 kW

* at Δt of 20 K and fully open balancing valve

CONNECTION IN A SYSTEM

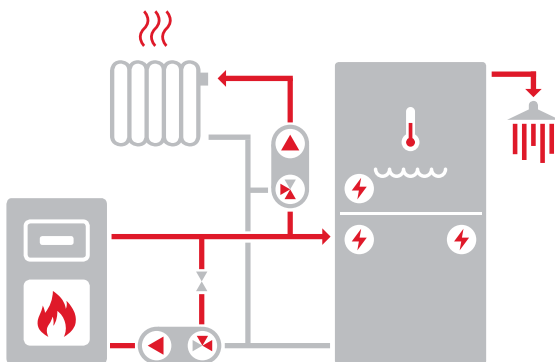

DIMENSIONS

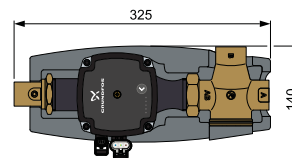

PROTECTION AGAINST BOILER CORROSION AND FOULING RegulusRGMAT Load Units



RGMAT EA G75 5/4

RegulusRGMAT Load Unit with thermostatic mixing and manual bypass balancing

RegulusRGMAT Load unit for solid-fuel boilers and fireplaces that **prevents low-temperature corrosion and boiler fouling by keeping a boiler (fireplace) inlet temperature** through a load valve.

RegulusRGMAT load unit comes in a left-hand version (outlet to boiler is on its left side), and can be easily modified to a right-hand version (outlet to boiler on its right side) during installation. Its installation position can be either horizontal or vertical.

RGMAT EA G75 5/4 consists of a Grundfos UPM3 FLEX AS 25-75 high efficiency circulation pump incl. connection cable, thermometer, insulation and TSV5 valve with a thermostatic element of 65 or 72°C opening temperature. **Balancing of TSV valve needs to be performed manually using a balancing valve in the bypass pipe.**

Boiler manufacturer ATMOS recommends that these models of load units are used with his boilers.

TECHNICAL DATA

FLUID WORKING TEMPERATURE	5 - 95 °C
POWER SUPPLY	230 V, 50 Hz
IP RATING	IP44
TOTAL WEIGHT	3.7 kg
CONNECTIONS	3x 5/4" F
K_{vs} from A to AB	7.0 m ³ /h
K_{vs} from B to AB	11.5 m ³ /h
MAX. HEAD	7.5 m
PUMP OPERATING POINTS at Δt 20 K	2.5 m ³ /h flow rate 4.2 m head
PUMP CONTROL	ON/OFF (Δp -c / Δp -v / I, II, III)

Prevention of low-temperature corrosion of boilers. Installation possible with A inlet from either right or left side. Minimum heat loss thanks to thermal insulation.

VERSIONS	CODE	VALVE OPENING TEMPERAT.	RECOMMENDED MAX. BOILER OUTPUT
RGMAT EA 65 G75 5/4	16399	65 °C	50 kW
RGMAT EA 72 G75 5/4	16400	72 °C	50 kW

* at Δt of 20 K and fully open balancing valve

CONNECTION IN A SYSTEM

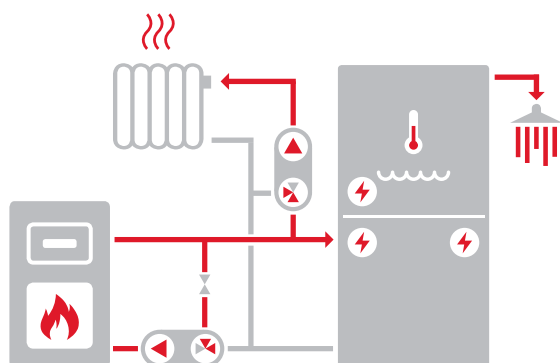

DIMENSIONS

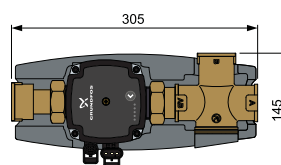

PROTECTION AGAINST BOILER CORROSION AND FOULING

RegulusRGMAT Load Units



RGMAT EA W6

RegulusRGMAT Load Unit with thermostatic mixing and manual bypass balancing

RegulusRGMAT Load unit for solid-fuel boilers and fireplaces that **prevents low-temperature corrosion and boiler fouling by keeping a boiler (fireplace) inlet temperature** through a load valve.

RegulusRGMAT load unit comes in a left-hand version (outlet to boiler is on its left side), and can be easily modified to a right-hand version (outlet to boiler on its right side) during installation. Its installation position can be either horizontal or vertical.

RGMAT EA W6 consists of a Wilo PARA 25/6 SC high efficiency circulation pump incl. connection cable, shut-off ball valve for the pump, thermometer, insulation and TSV3 valve with a thermostatic element of 65 or 72°C opening temperature. **Balancing of TSV valve needs to be performed manually using a balancing valve in the bypass pipe.**

Boiler manufacturer ATMOS recommends that these models of load units are used with his boilers.

TECHNICAL DATA

FLUID WORKING TEMPERATURE	5 - 95 °C
POWER SUPPLY	230 V, 50 Hz
IP RATING	IP44
TOTAL WEIGHT	3.6 kg
CONNECTIONS	3 x 1" F
K_{vs} from A to AB	6.2 m ³ /h
K_{vs} from B to AB	10.1 m ³ /h
MAX. HEAD	6.7 m
PUMP OPERATING POINTS at Δt 20 K	1.8 m ³ /h flow rate 3.7 m head
PUMP CONTROL	ON/OFF (Δp -c / Δp -v / I, II, III)

Prevention of low-temperature corrosion of boilers. Installation possible with A inlet from either right or left side. Minimum heat loss thanks to thermal insulation.

VERSIONS	CODE	VALVE OPENING TEMPERAT.	RECOMMENDED MAX. BOILER OUTPUT
RGMAT EA 65 W6	18699	65 °C	25 kW
RGMAT EA 72 W6	18701	72 °C	25 kW

* at Δt of 20 K and fully open balancing valve

CONNECTION IN A SYSTEM

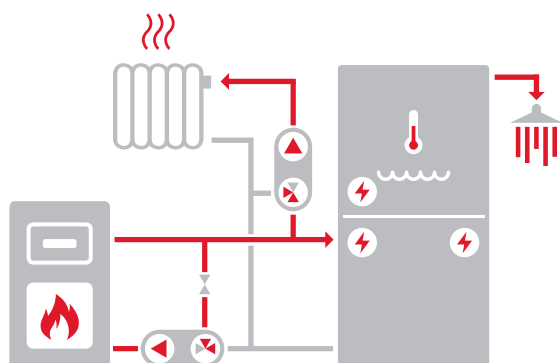

DIMENSIONS

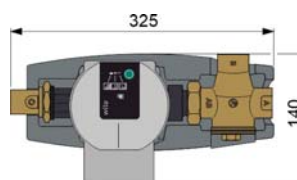

PROTECTION AGAINST BOILER CORROSION AND FOULING

RegulusRGMAT Load Units



RGMAT EA W8 5/4

RegulusRGMAT Load Unit with thermostatic mixing and manual bypass balancing

RegulusRGMAT Load unit for solid-fuel boilers and fireplaces that **prevents low-temperature corrosion and boiler fouling by keeping a boiler (fireplace) inlet temperature** through a load valve.

RegulusRGMAT load unit comes in a left-hand version (outlet to boiler is on its left side), and can be easily modified to a right-hand version (outlet to boiler on its right side) during installation. Its installation position can be either horizontal or vertical.

RGMAT EA W8 5/4 consists of a Wilo PARA 25/8 SC high efficiency circulation pump incl. connection cable, shut-off ball valve for the pump, thermometer, insulation and TSV5 valve with a thermostatic element of 65 or 72°C opening temperature. **Balancing of TSV valve needs to be performed manually using a balancing valve in the bypass pipe.**

Boiler manufacturer ATMOS recommends that these models of load units are used with his boilers.

TECHNICAL DATA

FLUID WORKING TEMPERATURE	5 - 95 °C
POWER SUPPLY	230 V, 50 Hz
IP RATING	IP44
TOTAL WEIGHT	3.3 kg
CONNECTIONS	3x 5/4"
K_{vs} from A to AB	7.0 m ³ /h
K_{vs} from B to AB	11.5 m ³ /h
MAX. HEAD	8.5 m
PUMP OPERATING POINTS at Δt 20 K	3.2 m ³ /h flow rate 3.2 m head
PUMP CONTROL	ON/OFF (Δp -c / Δp -v / I, II, III)

Prevention of low-temperature corrosion of boilers. Installation possible with A inlet from either right or left side. Minimum heat loss thanks to thermal insulation.

VERSIONS	CODE	VALVE OPENING TEMPERAT.	RECOMMENDED MAX. BOILER OUTPUT
RGMAT EA 65 W8 5/4	18700	65 °C	50 kW
RGMAT EA 72 W8 5/4	18637	72 °C	50 kW

* at Δt of 20 K and fully open balancing valve

CONNECTION IN A SYSTEM

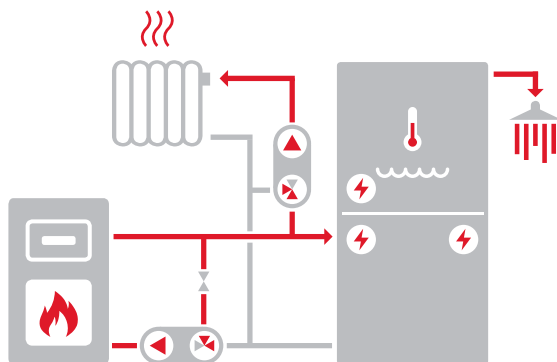

DIMENSIONS



PROTECTION AGAINST BOILER CORROSION AND FOULING

Accessories for RegulusRGMAT Load Units



BP RGMAT

Bypass with floating non-return valve

RegulusRGMAT Load units can be amended with a bypass with a floating non-return valve.

In case of a power failure or a broken circulation pump the boiler will cool down into the thermal store via gravity circulation through the bypass with a non-return valve.

VERSIONS

CODE

By-pass with a non-return valve for RGMAT with 1" connections



16126

By-pass with a non-return valve for RGMAT with 5/4" connections



16139

CONNECTION IN A SYSTEM

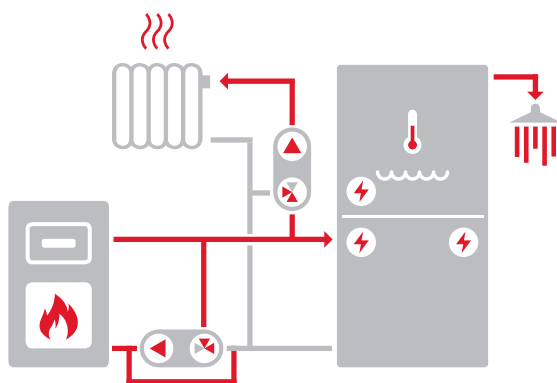

PROTECTION AGAINST BOILER CORROSION AND FOULING

ThermoMat Load Units



ThermoMat Load Unit with with thermostatic mixing and floating non-return valve

ThermoMat ECO+ LK 810 Load Unit mixes cool return water from a heating system (or thermal store) with hot water from a boiler flow, keeping boiler return water temperature at a given min. temperature (55°C, 65°C, 72°C, depending on the type).

The floating non-return valve permits boiler cooling through gravity circulation in case of a power failure or a circulation pump breakdown.

The load unit consists of:
 Grundfos UPM3 AUTO L Circulation pump
 Load valve
 By-pass with automatic balancing
 Floating non-return valve
 3 thermometers
 3 5/4" ball valves with union nuts
 Neat insulation for low heat loss

TECHNICAL DATA

FLUID WORKING TEMPERATURE	2 - 110 °C
MAX. WORKING PRESSURE	10 bar
POWER SUPPLY	230 V, 50 Hz
IP RATING	IP44
TOTAL WEIGHT	3.45 kg
CONNECTION	3 x G5/4" F
PUMP OPERATING POINTS at Δt 20 K	1.9 m ³ /h flow rate 4.6 m head
PUMP CONTROL	ON/OFF (Δp -c / Δp -v / I, II, III)

VERSIONS

	LK810 - 55	LK810 - 65	LK810 - 72
MIN. TEMPER. OF RETURN TO BOILER	55 °C	65 °C	72 °C
RECOMMENDED MAX. BOILER OUTPUT	56 kW	45 kW	41 kW
CODE	15046	15047	16244

CONNECTION IN A SYSTEM

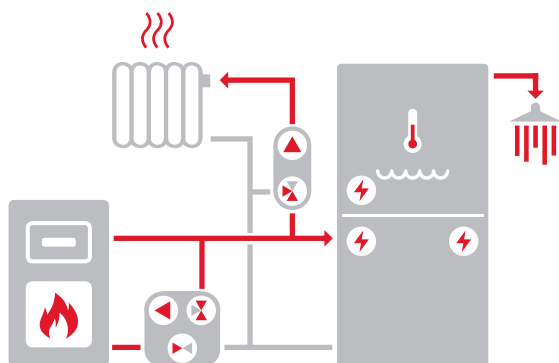

DIMENSIONS

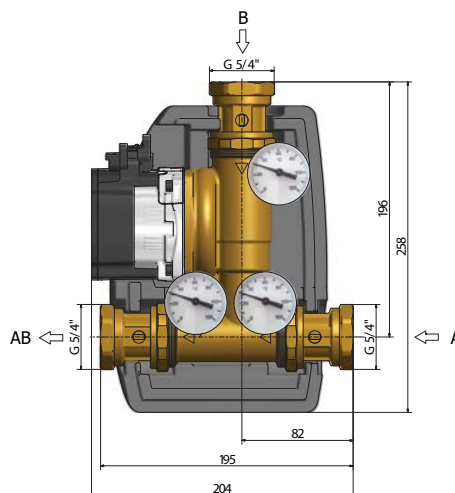

PROTECTION AGAINST BOILER CORROSION AND FOULING RegulusTOP Load Units



CSE MIX G Load Unit with electric actuated mixing

Load unit designed to control temperature in re- turn line of solid-fuel boilers or to control flow temperature to a mixed heating circuit using an external controller.

The load unit consists of:
 Grundfos circulation pump incl. power cable
 Mixing valve
 Load valve actuator
 Neat insulation for low heat loss

TECHNICAL DATA

FLUID WORKING TEMPERATURE	5 - 95 °C
MIXING VALVE ACTUATOR	3-point control, 120 s, 5 Nm
POWER SUPPLY	230 V, 50 Hz
IP RATING	IP44

1" F and 5/4" F load units are available also as variants without actuator.

VERSIONS

	CSE MIX G60 1M	CSE MIX G60 1F	CSE MIX G75 5/4F
CONNECTIONS	1" (2x M, 1x F)*	1" (3x F)	5/4" (3x F)
PUMP	Grundfos UPM3 AUTO 25-60	Grundfos UPM3 AUTO 25-60	Grundfos UPM3 FLEX 25-75
PUMP CONTROL	ON/OFF (Δp -c / Δp -v / I, II, III)	ON/OFF (Δp -c / Δp -v / I, II, III)	ON/OFF (I, II, III) or PWM-A (heating)
MAX. HEAD	6 m	6 m	7.5 m
K_{vs} OF THE VALVE	6.3 m ³ /h	10 m ³ /h	16 m ³ /h
CODE	19110	19106	16402

* the inner (F) thread is on the circulation pump side



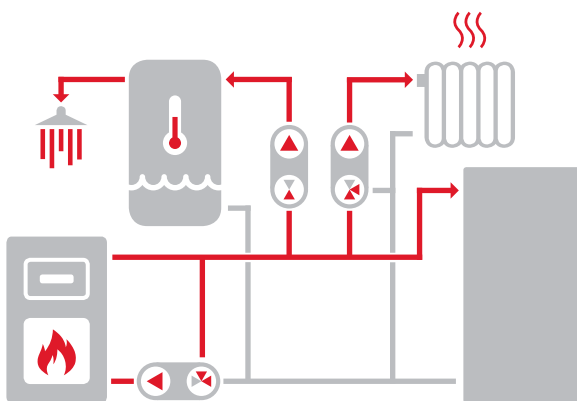

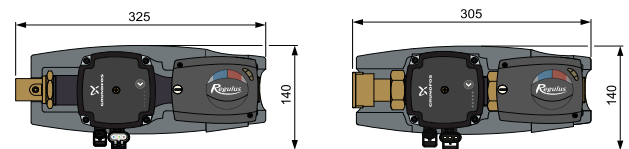

CONNECTION IN A SYSTEM



DIMENSIONS



ACCESSORIES

	NAME	APPLICATION	CODE
	F/Fu Fittings	to connect the valve (union nut x F)	15694
	1" Fu/M Union	to connect the valve (union nut x M)	15695
	1"x5/4" Fu/F Union	to connect to a 5/4" manifold	17920
	T-piece, 1" M/Fu/M, 125 mm	for easy connection to Regulus heating circuit manifolds	16659
	T-piece, 1" M/Fu/M, 90 mm	for easy connection of return line to mixing valve	16660
	CSE/HV Kit	2 threaded fittings, 1 T-piece, 1 ball valve	16922
	CSE/HV Kit with MFB	kit with a ball valve with filter & magnet	18330

PROTECTION AGAINST BOILER CORROSION AND FOULING

RegulusTOP Load Units



CSE MIX W

Load Unit with electric actuated mixing

Load unit designed to control temperature in re- turn line of solid-fuel boilers or to control flow temperature to a mixed heating circuit using an external controller.

The load unit consists of:
 Wilo Circulation pump incl. power cable
 Mixing valve
 Mixing valve actuator
 Neat insulation for low heat loss

TECHNICAL DATA

FLUID WORKING TEMPERATURE	5 - 95 °C
MIXING VALVE ACTUATOR	3-point control, 120 s, 5 Nm
POWER SUPPLY	230 V, 50 Hz
IP RATING	IP44

1" F and 5/4" F load units are available also as variants without actuator.

VERSIONS	CSE MIX W8 1M	CSE MIX W6 1M	CSE MIX W6 1F	CSE MIX W-PWM 1F	CSE MIX W8 5/4F
CONNECTIONS	1" (2x M, 1x F)*	1" (2x M, 1x F)*	1" (3x F)	1" (3x F)	5/4" (3x F)
WILO PUMP	PARA 25/8 SC	PARA 25/6 SC	PARA 25/6 SC	PARA 25/8 iPWM1	PARA 25/8 SC
PUMP CONTROL	ON/OFF (Δp -c / Δp -v / I, II, III)	ON/OFF (Δp -c / Δp -v / I, II, III)	ON/OFF (Δp -c / Δp -v / I, II, III)	PWM1 (heating) + flowrate info	ON/OFF (Δp -c / Δp -v / I, II, III)
MAX. HEAD	8.4 m	6.7 m	6.7 m	8.4 m	8.5 m
K _{Vs} OF THE MIXING VALVE	6.3 m ³ /h	6.3 m ³ /h	10 m ³ /h	10 m ³ /h	16 m ³ /h
CODE	17980	18730	18317	18128	18524

* the inner (F) thread is on the circulation pump side



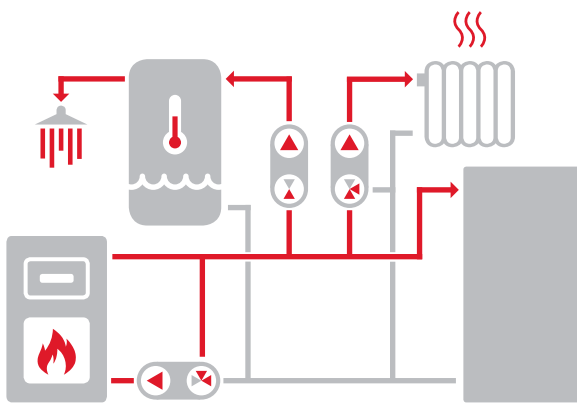

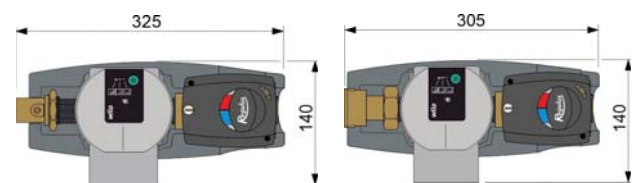

CONNECTION IN A SYSTEM



DIMENSIONS



ACCESSORIES

NAME	APPLICATION	CODE
 F/Fu Fittings	to connect the valve (union nut x F)	15694
 1" Fu/M Union	to connect the valve (union nut x M)	15695
 1"x5/4" Fu/F Union	to connect to a 5/4" manifold	17920
 T-piece, 1" M/Fu/M, 125 mm	for easy connection to Regulus heating circuit manifolds	16659
 T-piece, 1" M/Fu/M, 90 mm	for easy connection of return line to mixing valve	16660
 CSE/HV Kit	2 threaded fittings, 1 T-piece, 1 ball valve	16922
 CSE/HV Kit with MFB	kit with a ball valve with filter & magnet	18330

PROTECTION AGAINST BOILER CORROSION AND FOULING

TSV load valves keep a boiler return temperature at least at the valve opening temperature, preventing boiler corrosion and fouling. The boiler then works with higher efficiency and its service life is extended. The valve contains a thermostatic element that facilitates mixing outgoing hot water with return water from a heating system or thermal store.

All valve models for 45°C, 55°C and 65°C are fitted with thermostatic elements with rubber gaskets that guarantee high tightness, preventing microcirculation in periods when the boiler is extinguished. Microcirculation via a boiler is the reason why a thermal store cools down due to heat loss via the boiler to chimney.

All valves feature robust design with large cross sections for heating water flow. That is why they are not inclined to getting clogged when installed into older heating systems.

TSV B Valve with automatic by-pass balancing

TSV B valve controls flow through both A and B inlets, closing them tight at end positions. The outlet temperature is kept in the range of 5°C from nominal temperature upwards. This exact control prevents boiler overheating and keeps a steady flow rate through a boiler under any conditions if the system is properly designed.

When restricting the flow through one port, it opens the other one simultaneously. At the end of the control range, the by-pass (port B) is tightly closed and the inlet from a heating system (port A) fully open. Due to this, the incoming water temperature to a boiler is kept at lower values than with a valve without automatic by-pass control, and so the boiler can work at full power even with very hot return water.

The installation of a TSV B valve is easier and its control more precise than that of valves without automatic balancing. It is very suitable for higher-output boilers.

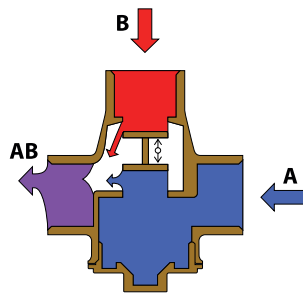

TSV Valve with manual by-pass balancing

TSV valve controls flow through both A and B inlets, closing them tight at end positions. **The port B is always open, unrestricted.**

Flow through the by-pass is restricted only by the manually adjusted valve, so the return line temperature can rise disregarded of the temperature reached.

When cold, the inlet from a heating system (port A) is closed by the thermostatic element integrated in the valve. Heating water flows from the boiler through by-pass (port B) and via the valve outlet (port AB) back to the boiler. When the opening temperature of the thermostatic element is reached, it starts opening the inlet from a heating system (port A). Colder water (from port A) starts mixing with hot water (from port B). The thermostatic element controls the cold water inlet (through port A) in such a manner that the outlet temperature does not sink below the valve opening temperature. The inlet from the by-pass (port B) remains permanently open.

In case of a higher return water temperature this may result in blending more hot water from the boiler than necessary which in turn brings very high outlet temperature from the valve (port AB), causing possible boiler overheating. For this reason the by-pass pipe **shall be fitted with a balancing valve that will limit the flow.**

Boiler manufacturer ATMOS recommends that these models of TSV valves are used with his boilers.

How the TSV outlet temperature depends on the inlet temperature from a heating system

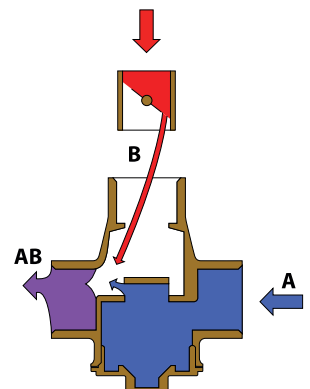
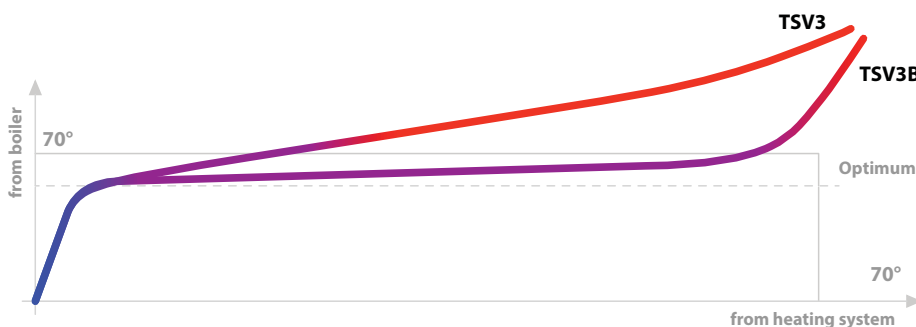

OVERVIEW OF TSV B VALVES WITH AUTOMATIC BY-PASS BALANCING



MODELS		TSV3B	TSV5B	TSV6B	TSV8B
Nominal diameter DN	[-]	25	32	40	50
Connection size	["]	1" F	5/4" F	6/4" F	2" F
Flow coefficient K_{vs} from A to AB	[m ³ /h]	6.2	7	13.3	15.8
Flow coefficient K_{vs} from B to AB	[m ³ /h]	4.4	4.9	9.6	11.1
Weight	[kg]	0.77	0.87	1.7	1.85
Codes for temperature and tightness		TSV3B	TSV5B	TSV6B	TSV8B
Opening temperature 45 °C		11282	11806	12974	12977
Opening temperature 50 °C		15517	15520	-	-
Opening temperature 55 °C		11281	11807	12975	12978
Opening temperature 60 °C		15518	15521	-	-
Opening temperature 65 °C		10080	11808	12976	12979
Opening temperature 70 °C		15519	15522	-	-

OVERVIEW OF TSV VALVES WITH MANUAL BY-PASS BALANCING



MODELS		TSV3	TSV5	TSV6	TSV8
Nominal diameter DN	[-]	25	32	40	50
Connection size	["]	1" F	5/4" F	6/4" F	2" F
Flow coefficient K_{vs} from A to AB	[m ³ /h]	6.2	7	13.3	15.8
Flow coefficient K_{vs} from B to AB	[m ³ /h]	10.1	11.5	19.8	27.4
Weight	[kg]	0.75	0.85	1.6	1.75
Codes for temperature and tightness		TSV3	TSV5	TSV6	TSV8
Opening temperature 65 °C		10347	11804	11821	11819
Opening temperature 72 °C		16029	15533	16060	16061
Opening temperature 77 °C (final sale)		10742	11836	-	-

- in this version not available



INSULATION SETS

MODELS		TSV3, TSV3B	TSV5, TSV5B	TSV6, TSV6B	TSV8, TSV8B
Code	[-]	14979	14980	11874	11875

PROTECTION AGAINST BOILER CORROSION AND FOULING

Load Valves with automatic by-pass balancing



TSV3B

Valves for return temperature control, with automatic by-pass balancing

TSV B load valves mix cool return water from a heating system or thermal store with hot water from a boiler flow, **keeping boiler return water** (i.e. its heat transfer surfaces) at a temperature that will **not allow condensation to occur**. The boiler then works with higher efficiency and its service life is extended.

The valves feature automatic by-pass balancing. The exact control prevents boiler overheating and keeps a steady flow rate through a boiler under any temperature if the system is properly designed. When restricting the flow through one inlet, it opens the other one simultaneously.

DIMENSIONS

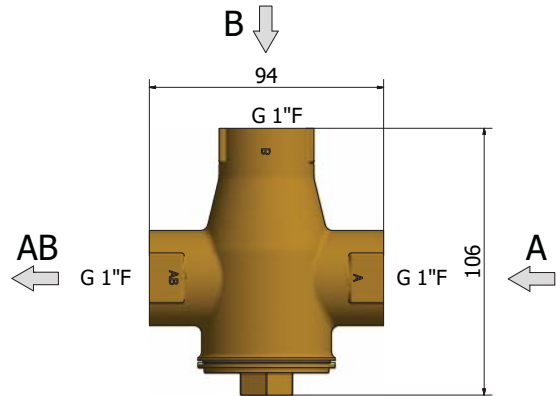

VERSIONS

		TSV3B 45	TSV3B 50	TSV3B 55	TSV3B 60	TSV3B 65	TSV3B 70
OPENING TEMPERATURE	°C	45	50	55	60	65	70
NOMINAL DIAMETER	-	DN25	DN25	DN25	DN25	DN25	DN25
CONNECTION SIZE	--	G 1" F	G 1" F	G 1" F	G 1" F	G 1" F	G 1" F
K_{vs} from A to AB	m ³ /h	6.2	6.2	6.2	6.2	6.2	6.2
K_{vs} from B to AB	m ³ /h	4.4	4.4	4.4	4.4	4.4	4.4
WEIGHT	kg	0.77	0.77	0.77	0.77	0.77	0.77
CODE	--	11282	15517	11281	15518	10080	15519

CONNECTION IN A SYSTEM

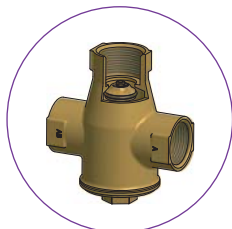

TSVB valve with automatic by-pass balancing

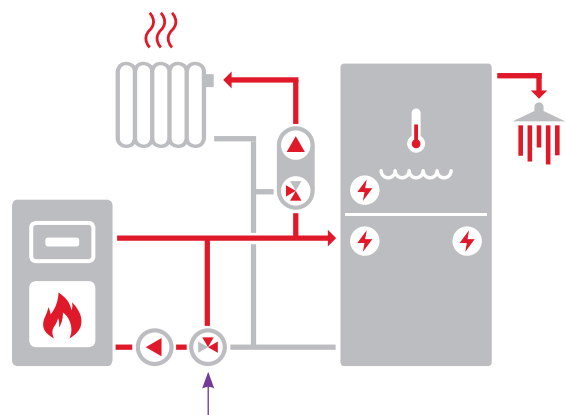

PROTECTION AGAINST BOILER CORROSION AND FOULING

Load Valves with manual by-pass balancing



TSV3

Valves for return temperature control, with manual by-pass balancing

TSV load valves with manual by-pass adjustment mix cool return water from a heating system or thermal store with hot water from a boiler flow, **keeping boiler return water** (i.e. its heat transfer surfaces) at a temperature that will **not allow condensation to occur**. The boiler then works with higher efficiency and its service life is extended.

Balancing of TSV3 valves needs to be performed manually using a balancing valve in the by-pass pipe. Boiler manufacturer ATMOS recommends that these models of TSV valves are used with his boilers.

DIMENSIONS

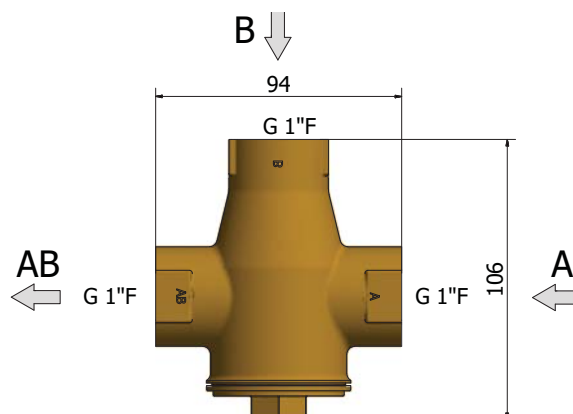

VERSIONS

	TSV3 65	TSV3 72	TSV3 77
OPENING TEMPERATURE	65 °C	72 °C	77 °C
NOMINAL DIAMETER	DN25	DN25	DN25
CONNECTION SIZE	G 1" F	G 1" F	G 1" F
MAX. WORKING PRESSURE	6 bar	6 bar	6 bar
K_{vs} from A to AB	6.2 m ³ /h	6.2 m ³ /h	6.2 m ³ /h
K_{vs} from B to AB	10.1 m ³ /h	10.1 m ³ /h	10.1 m ³ /h
WEIGHT	0.75 kg	0.75 kg	0.75 kg
CODE	10347	16029	10742

CONNECTION IN A SYSTEM

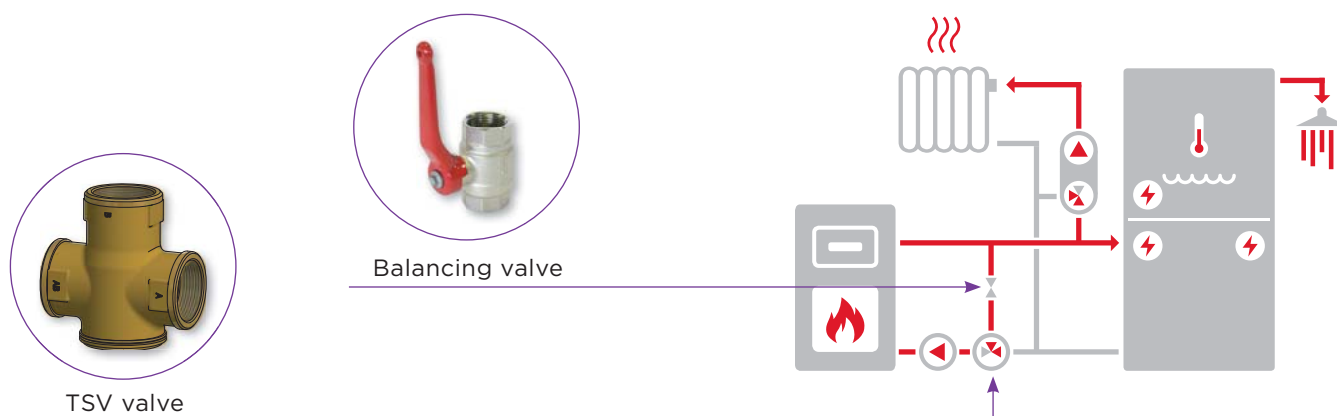

PROTECTION AGAINST BOILER CORROSION AND FOULING

Load Valves with automatic by-pass balancing



TSV3BF

Valves for return temperature control, with automatic by-pass balancing

Load valve with automatic by-pass balancing, with 1" F threads on both A and B inlets. The AB outlet is fitted with a 6/4" F union nut, it involves also a 6/4" F x 1" F union. The kit is intended to connect a circulation pump.

DIMENSIONS

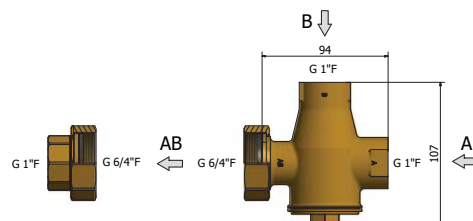

VERSIONS

		TSV3BF 45	TSV3BF 50	TSV3BF 55	TSV3BF 60	TSV3BF 65	TSV3BF 70
OPENING TEMPERATURE	°C	45	50	55	60	65	70
INLET CONNECTION SIZE	--	G 1" F	G 1" F	G 1" F	G 1" F	G 1" F	G 1" F
OUTLET CONNECTION SIZE	--	G 6/4" Fu	G 6/4" Fu	G 6/4" Fu	G 6/4" Fu	G 6/4" Fu	G 6/4" Fu
K_{vs} from A to AB	m ³ /h	6.2	6.2	6.2	6.2	6.2	6.2
K_{vs} from B to AB	m ³ /h	4.4	4.4	4.4	4.4	4.4	4.4
WEIGHT	kg	0.81	0.81	0.81	0.81	0.81	0.81
CODE	--	13095	15939	13096	15940	13097	15941

TSV3BMF

Valves for return temperature control, with automatic by-pass balancing



Load valve with automatic by-pass balancing, with 1" M threads on both A and B inlets and a 1" F union nut on the AB outlet. The union nut permits direct connection to a circulation pump with 1" connection size.

DIMENSIONS

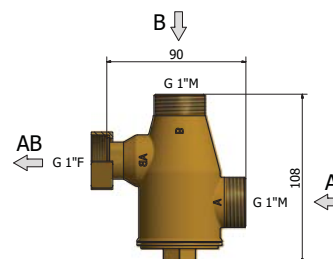

VERSIONS

		TSV3BMF 45	TSV3BMF 55	TSV3BMF 65
OPENING TEMPERATURE	°C	45	55	65
INLET CONNECTION SIZE	--	G 1" M	G 1" M	G 1" M
OUTLET CONNECTION SIZE	--	G 1" Fu	G 1" Fu	G 1" Fu
K_{vs} from A to AB	m ³ /h	8.6	8.6	8.6
K_{vs} from B to AB	m ³ /h	5.1	5.1	5.1
WEIGHT	kg	0.69	0.69	0.69
CODE	--	13980	13981	13982

50, 60, 70 °C temperatures upon request

PROTECTION AGAINST BOILER CORROSION AND FOULING

Load Valves with automatic by-pass balancing



TSV3BM

Valves for return temperature control, with automatic by-pass balancing

Load valve with automatic by-pass balancing and 1" M threads permitting easy connection to copper pipes with union nuts, e.g. when integrated into a boiler.

DIMENSIONS

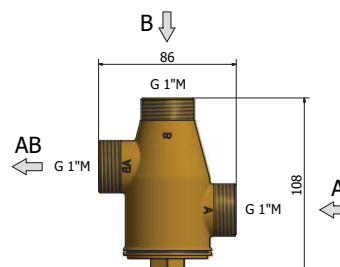

VERSIONS

		TSV3BM 45	TSV3BM 50	TSV3BM 55	TSV3BM 65
OPENING TEMPERATURE	°C	45	50	55	65
CONNECTION SIZE	--	G 1" M	G 1" M	G 1" M	G 1" M
K_{vs} from A to AB	m ³ /h	9.8	9.8	9.8	9.8
K_{vs} from B to AB	m ³ /h	5.3	5.3	5.3	5.3
WEIGHT	kg	0.65	0.65	0.65	0.65
CODE	--	13977	18855	13978	13979

50, 60, 70 °C temperatures upon request

TSV34BM

Valves for return temperature control, with automatic by-pass balancing

Load valve with automatic by-pass balancing and 3/4" F threads permitting easy connection using copper pipes with union nuts, e.g. for installation into a boiler.



DIMENSIONS

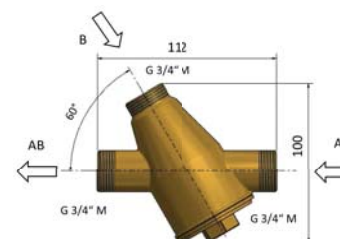

VERSIONS

		TSV34BM 45	TSV34BM 55	TSV34BM 65
OPENING TEMPERATURE	°C	45	55	65
CONNECTION SIZE	--	G 3/4" M	G 3/4" M	G 3/4" M
K_{vs} from A to AB	m ³ /h	5.6	5.6	5.6
K_{vs} from B to AB	m ³ /h	5.6	5.6	5.6
WEIGHT	kg	0.6	0.6	0.6
CODE	--	16928	16409	16929

Only on order!

PROTECTION AGAINST BOILER CORROSION AND FOULING

Load Valves with automatic by-pass balancing



TSV5BMF

Valves for return temperature control, with automatic by-pass balancing

TSV B load valves mix cool return water from a heating system or thermal store with hot water from a boiler flow, **keeping boiler return water** (i.e. its heat transfer surfaces) at a temperature that **will not allow condensation to occur**. The boiler then works with higher efficiency and its service life is extended.

The valves feature automatic by-pass balancing. The exact control prevents boiler overheating and keeps a steady flow rate through a boiler under any temperature if the system is properly designed. When restricting the flow through one inlet, it opens the other one simultaneously.

DIMENSIONS

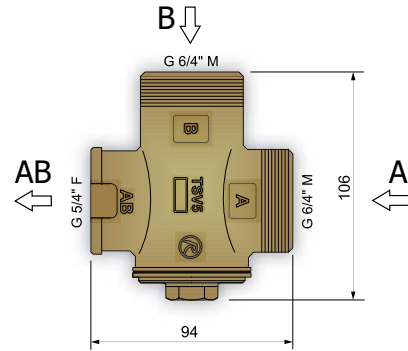

VERSIONS

		TSVBMF 55	TSVBMF 65
OPENING TEMPERATURE	°C	55	65
NOMINAL DIAMETER	-	DN32	DN32
INLET CONNECTION SIZE	--	G 6/4" M	G 6/4" M
OUTLET CONNECTION SIZE	--	G 5/4" F	G 5/4" F
K_{vs} from A to AB	m ³ /h	7.0	7.0
K_{vs} from B to AB	m ³ /h	6.0	6.0
WEIGHT	kg	0.96	0.96
CODE	--	18655	18656

CONNECTION IN A SYSTEM

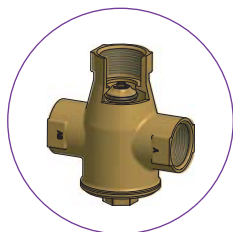

TSVBMF valve with automatic by-pass balancing

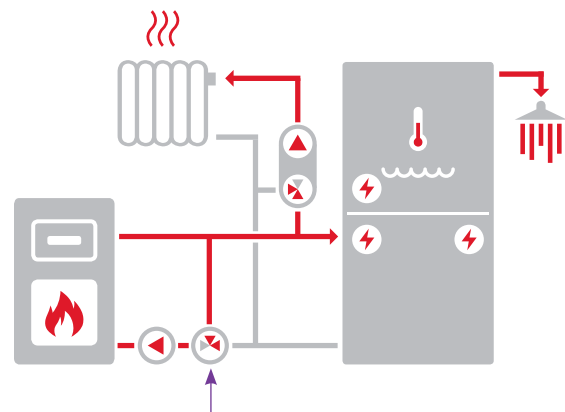

ACCESSORIES

Union 6/4"x5/4" F/M incl. gasket, brass

Code: 19058

PROTECTION AGAINST BOILER CORROSION AND FOULING

Load Valves with automatic by-pass balancing



TSV5B

Valves for return temperature control, with automatic by-pass balancing

TSV B load valves mix cool return water from a heating system or thermal store with hot water from a boiler flow, **keeping boiler return water** (i.e. its heat transfer surfaces) at a temperature that **will not allow condensation to occur**. The boiler then works with higher efficiency and its service life is extended.

The valves feature automatic by-pass balancing. The exact control prevents boiler overheating and keeps a steady flow rate through a boiler under any temperature if the system is properly designed. When restricting the flow through one inlet, it opens the other one simultaneously.

DIMENSIONS

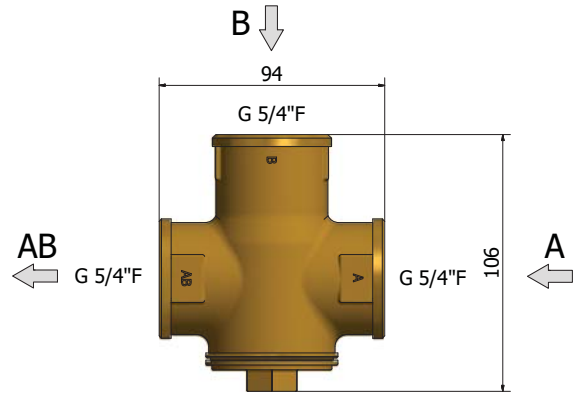

VERSIONS

		TSV5B 45	TSV5B 50	TSV5B 55	TSV5B 60	TSV5B 65	TSV5B 70
OPENING TEMPERATURE	°C	45	50	55	60	65	70
NOMINAL DIAMETER	-	DN32	DN32	DN32	DN32	DN32	DN32
CONNECTION SIZE	--	G 5/4" F	G 5/4" F	G 5/4" F	G 5/4" F	G 5/4" F	G 5/4" F
K_{vs} from A to AB	m ³ /h	7.0	7.0	7.0	7.0	7.0	7.0
K_{vs} from B to AB	m ³ /h	4.9	4.9	4.9	4.9	4.9	4.9
WEIGHT	kg	0.87	0.87	0.87	0.87	0.87	0.87
CODE	--	11806	15520	11807	15521	11808	15522

CONNECTION IN A SYSTEM

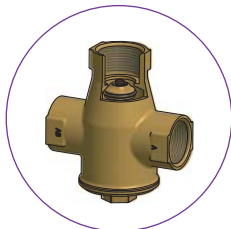

TSVB valve with automatic by-pass balancing

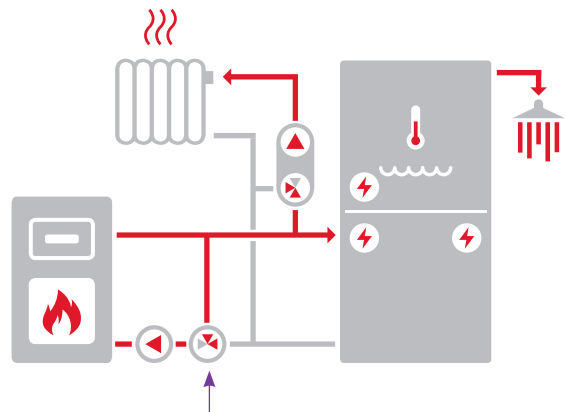

PROTECTION AGAINST BOILER CORROSION AND FOULING

Load Valves with manual by-pass balancing



TSV5

Valves for return temperature control, with manual by-pass balancing

TSV load valves with manual by-pass adjustment mix cool return water from a heating system or thermal store with hot water from a boiler flow, **keeping boiler return water** (i.e. its heat transfer surfaces) at a temperature that **will not allow condensation to occur**. The boiler then works with higher efficiency and its service life is extended.

Balancing of TSV5 valves needs to be performed manually using a balancing valve in the by-pass pipe. Boiler manufacturer ATMOS recommends that these models of TSV valves are used with his boilers.

DIMENSIONS

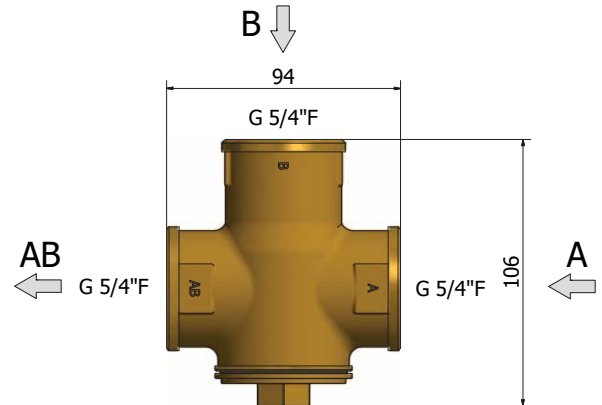

VERSIONS

	TSV5 65	TSV5 72	TSV5 77
OPENING TEMPERATURE	65 °C	72 °C	77 °C
NOMINAL DIAMETER	DN32	DN32	DN32
CONNECTION SIZE	G 5/4" F	G 5/4" F	G 5/4" F
MAX. WORKING PRESSURE	6 bar	6 bar	6 bar
K_{vs} from A to AB	7.0 m ³ /h	7.0 m ³ /h	7.0 m ³ /h
K_{vs} from B to AB	11.5 m ³ /h	11.5 m ³ /h	11.5 m ³ /h
WEIGHT	0.85 kg	0.85 kg	0.85 kg
CODE	11804	15533	11836

CONNECTION IN A SYSTEM

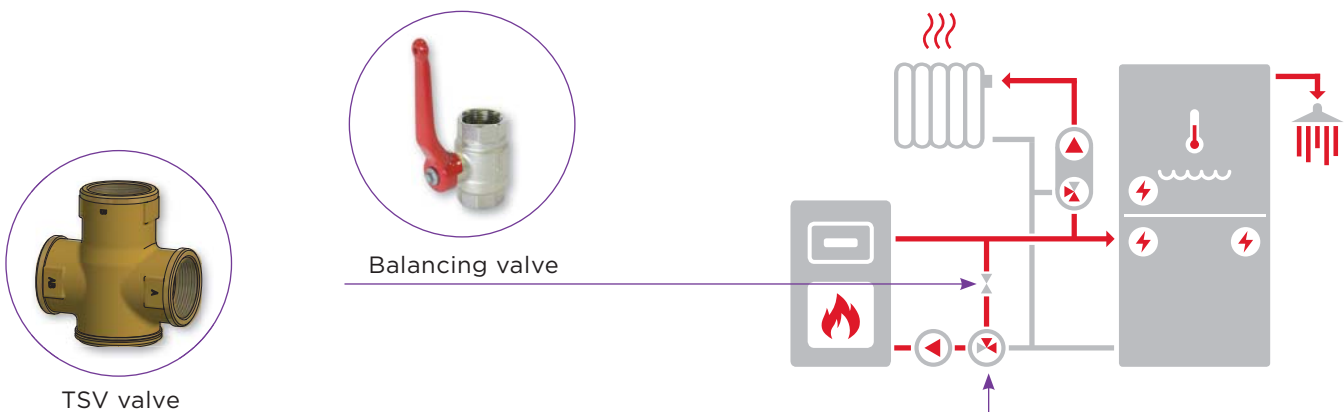

PROTECTION AGAINST BOILER CORROSION AND FOULING

Load Valves with automatic by-pass balancing



TSV6B

Valves for return temperature control, with automatic by-pass balancing

TSV B load valves mix cool return water from a heating system or thermal store with hot water from a boiler flow, **keeping boiler return water** (i.e. its heat transfer surfaces) at a temperature that **will not allow condensation to occur**. The boiler then works with higher efficiency and its service life is extended.

The valves feature automatic by-pass balancing. The exact control prevents boiler overheating and keeps a steady flow rate through a boiler under any temperature if the system is properly designed. When restricting the flow through one inlet, it opens the other one simultaneously.

DIMENSIONS

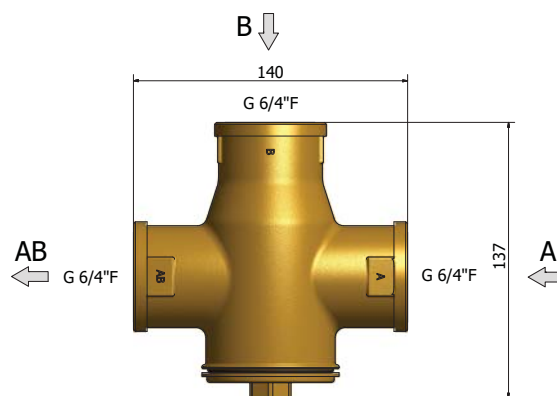

VERSIONS

		TSV6B 45	TSV6B 55	TSV6B 65
OPENING TEMPERATURE	°C	45	55	65
NOMINAL DIAMETER	-	DN40	DN40	DN40
CONNECTION SIZE	--	G 6/4" F	G 6/4" F	G 6/4" F
K_{vs} from A to AB	m ³ /h	13.3	13.3	13.3
K_{vs} from B to AB	m ³ /h	9.6	9.6	9.6
WEIGHT	kg	1.7	1.7	1.7
CODE	--	12974	12975	12976

CONNECTION IN A SYSTEM

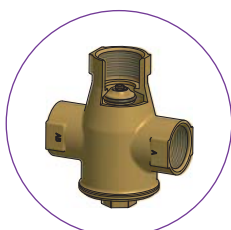

TSVB valve with automatic by-pass balancing

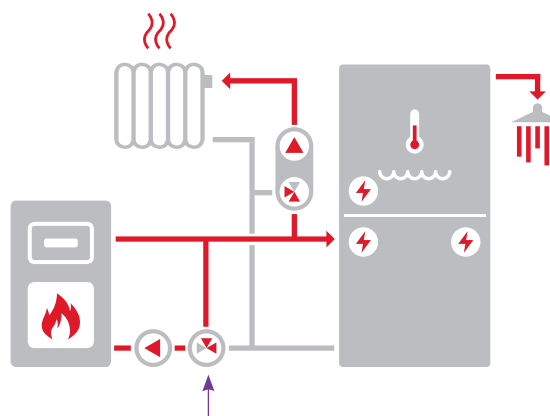

PROTECTION AGAINST BOILER CORROSION AND FOULING

Load Valves with manual by-pass balancing



TSV6

Valves for return temperature control, with manual by-pass balancing

TSV load valves with manual by-pass adjustment mix cool return water from a heating system or thermal store with hot water from a boiler flow, **keeping boiler return water** (i.e. its heat transfer surfaces) at a temperature that **will not allow condensation to occur**. The boiler then works with higher efficiency and its service life is extended.

Balancing of TSV6 valves needs to be performed manually using a balancing valve in the by-pass pipe. Boiler manufacturer ATMOS recommends that these models of TSV valves are used with his boilers.

DIMENSIONS

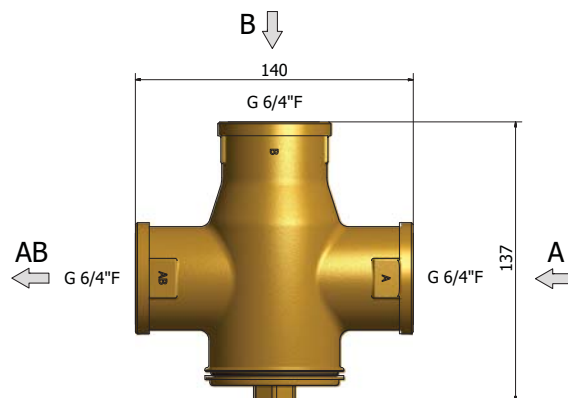

VERSIONS

	TSV6 65	TSV6 72
OPENING TEMPERATURE	65 °C	72 °C
NOMINAL DIAMETER	DN40	DN40
CONNECTION SIZE	G 6/4" F	G 6/4" F
MAX. WORKING PRESSURE	6 bar	6 bar
K_{vs} from A to AB	13.3 m ³ /h	13.3 m ³ /h
K_{vs} from B to AB	19.8 m ³ /h	19.8 m ³ /h
WEIGHT	1.6 kg	1.6 kg
CODE	11821	16060

CONNECTION IN A SYSTEM

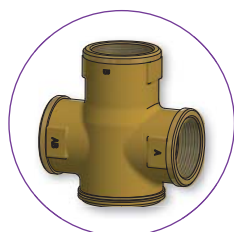

TSV valve



Balancing valve

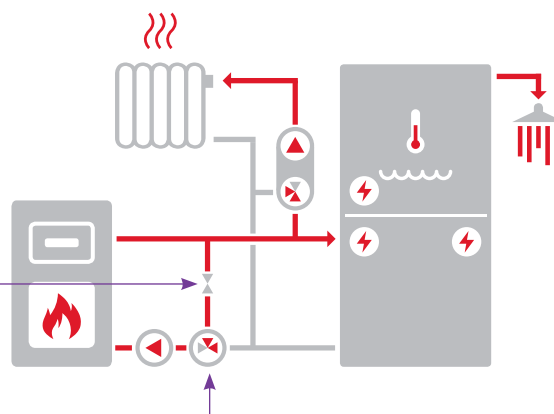

PROTECTION AGAINST BOILER CORROSION AND FOULING

Load Valves with automatic by-pass balancing



TSV8B

Valves for return temperature control, with automatic by-pass balancing

TSV B load valves mix cool return water from a heating system or thermal store with hot water from a boiler flow, **keeping boiler return water** (i.e. its heat transfer surfaces) at a temperature that **will not allow condensation to occur**. The boiler then works with higher efficiency and its service life is extended.

The valves feature automatic by-pass balancing. The exact control prevents boiler overheating and keeps a steady flow rate through a boiler under any temperature if the system is properly designed. When restricting the flow through one inlet, it opens the other one simultaneously.

DIMENSIONS

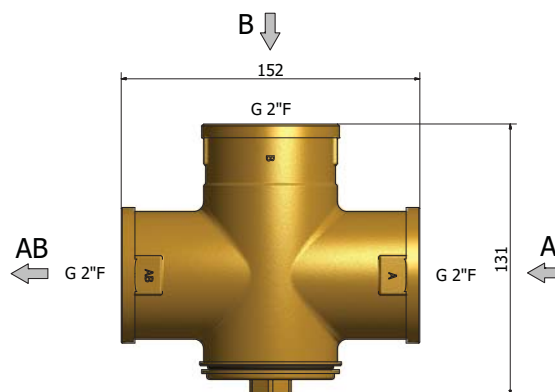

VERSIONS

		TSV8B 45	TSV8B 55	TSV8B 65
OPENING TEMPERATURE	°C	45	55	65
NOMINAL DIAMETER	-	DN50	DN50	DN50
CONNECTION SIZE	--	G 2" F	G 2" F	G 2" F
K_{vs} from A to AB	m^3/h	15.8	15.8	15.8
K_{vs} from B to AB	m^3/h	11.1	11.1	11.1
WEIGHT	kg	1.85	1.85	1.85
CODE	--	12977	12978	12979

CONNECTION IN A SYSTEM

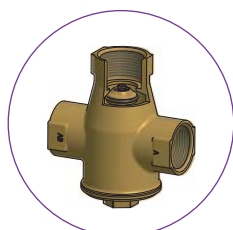

TSVB valve with automatic by-pass balancing

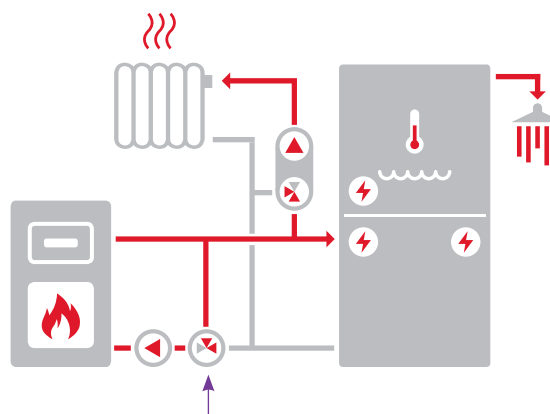

PROTECTION AGAINST BOILER CORROSION AND FOULING

Load Valves with manual by-pass balancing



TSV8

Valves for return temperature control, with manual by-pass balancing

TSV load valves with manual by-pass adjustment mix cool return water from a heating system or thermal store with hot water from a boiler flow, **keeping boiler return water** (i.e. its heat transfer surfaces) at a temperature that **will not allow condensation to occur**. The boiler then works with higher efficiency and its service life is extended.

Balancing of TSV8 valves needs to be performed manually using a balancing valve in the by-pass pipe. Boiler manufacturer ATMOS recommends that these models of TSV valves are used with his boilers.

DIMENSIONS

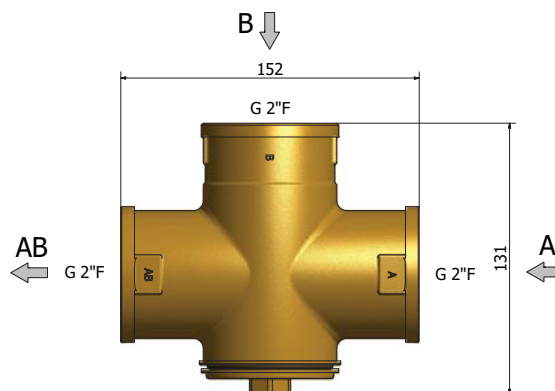

VERSIONS

	TSV8 65	TSV8 72
OPENING TEMPERATURE	65 °C	72 °C
NOMINAL DIAMETER	DN50	DN50
CONNECTION SIZE	G 2" F	G 2" F
MAX. WORKING PRESSURE	6 bar	6 bar
K_{vs} from A to AB	15.8 m ³ /h	15.8 m ³ /h
K_{vs} from B to AB	27.4 m ³ /h	27.4 m ³ /h
WEIGHT	1.75 kg	1.75 kg
CODE	11819	16061

CONNECTION IN A SYSTEM

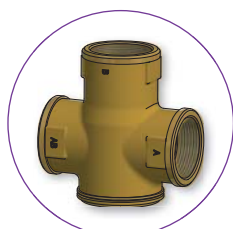

TSV valve



Balancing valve

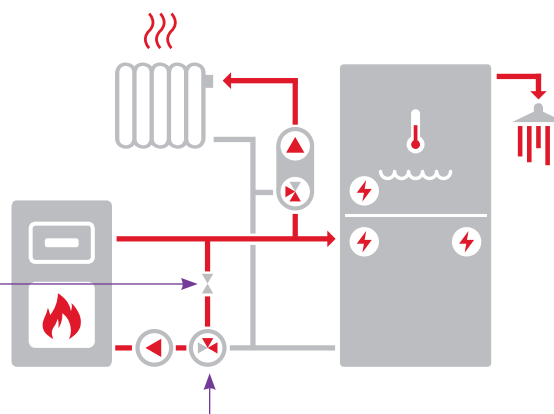

PROTECTION AGAINST BOILER CORROSION AND FOULING

Circulation Pumps



Grundfos circulation pump performance curves

Grundfos UPM3 FLEX AS 25-60

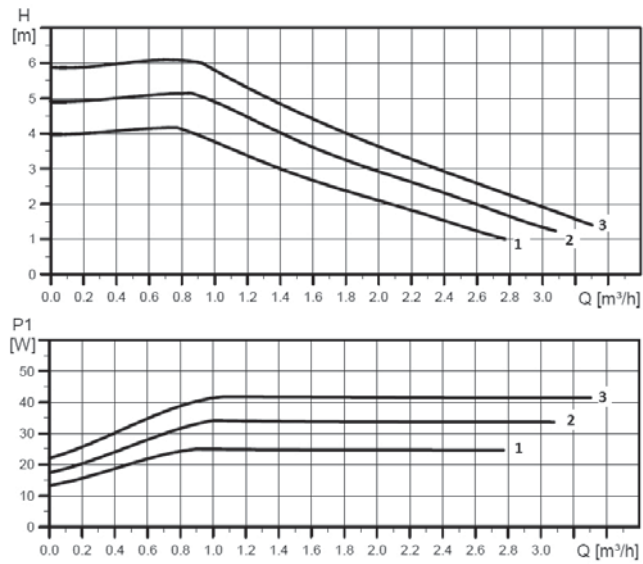

Grundfos UPM3 FLEX AS 25-75

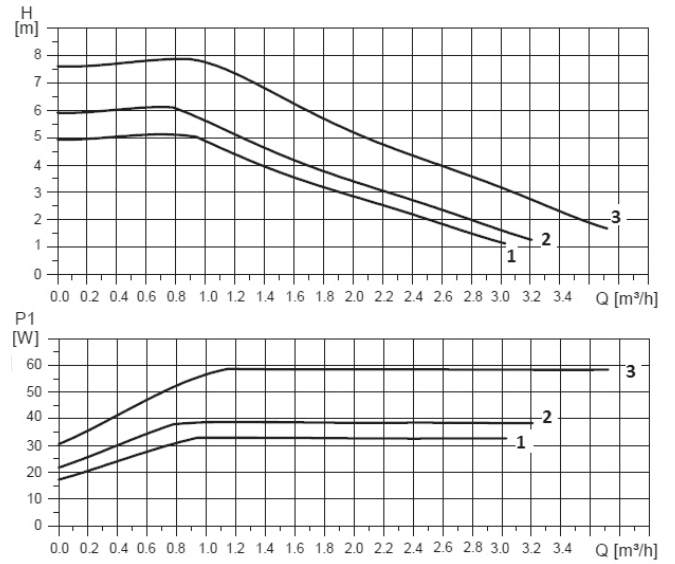

Grundfos UPM3 AUTO 25-60

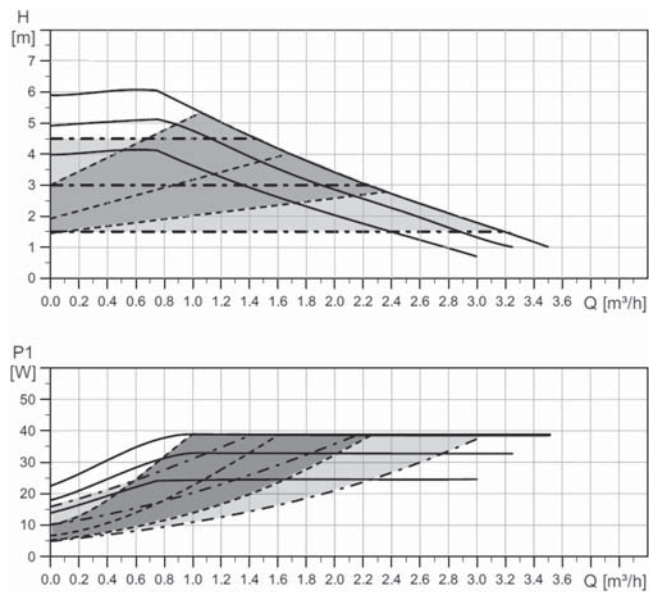

PROTECTION AGAINST BOILER CORROSION AND FOULING

Circulation Pumps



Wilo circulation pump performance curves

Wilo PARA 25/6 SC

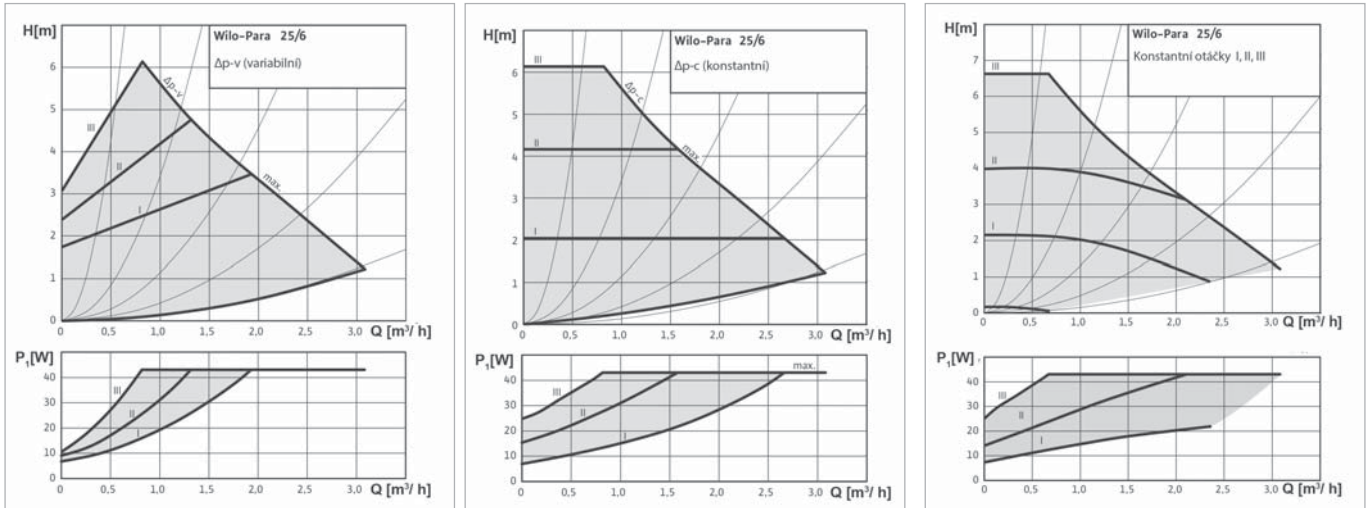

PROTECTION AGAINST BOILER CORROSION AND FOULING Circulation Pumps



Wilo circulation pump performance curves

Wilo PARA 25/8 SC

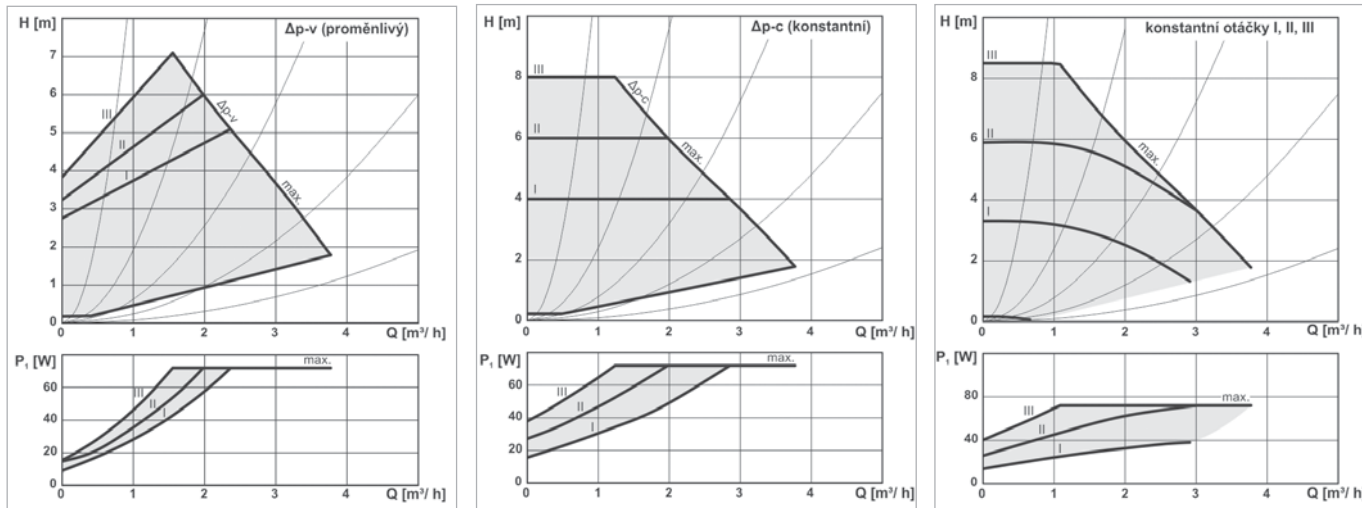

Wilo PARA 25/8 iPWM1

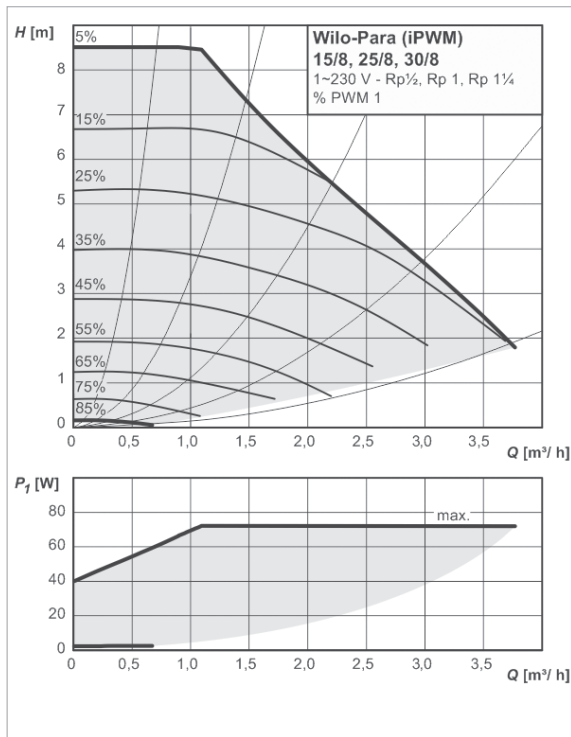

BOILER OUTPUT CONTROL

RT4 Thermostatic draft regulator

Thermostatic draft regulator for solid fuel boilers designed to control boiler output by opening or throttling a combustion air damper. The boiler output is modified in such a way that the working fluid temperature (heating water, antifreeze fluid, heat transfer oil) at the boiler outlet reaches the temperature set by the knob.

The regulator can be installed vertically or horizontally. Its working position (orientation) shall correspond to the picture “Working positions of RT4 regulator”.



TECHNICAL DATA

CONNECTION SIZE	G 3/4" M
NOMINAL PRESSURE	PN 6
MAX. WORKING PRESSURE	0.6 MPa
MAX. FLUID WORKING TEMPERATURE	120 °C
CONTROL RANGE OF FLUID TEMPERATURE	30 - 90 °C
MAX. AMBIENT TEMPERATURE	60 °C
CHAIN LOAD	100 - 1 000 g
WEIGHT	420 g
CODE	13878

DIMENSIONS

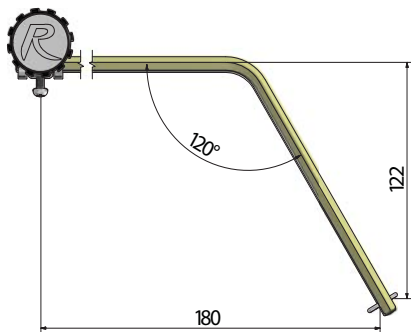
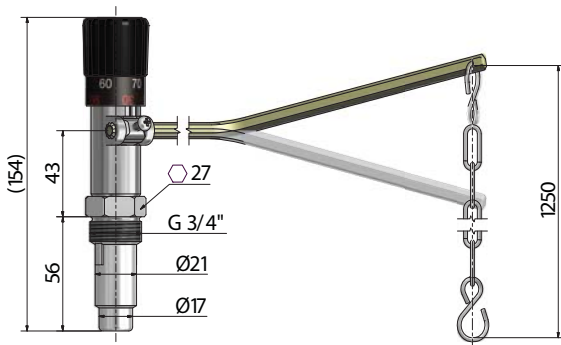

Advantages of RT4 draft regulator:

- High control power
- Resistance to dusty environment
- Its design permits disassembly
- Nickel plated sheath

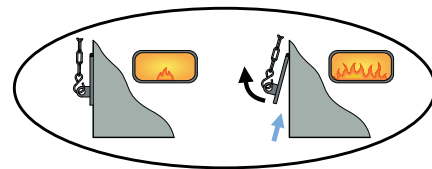
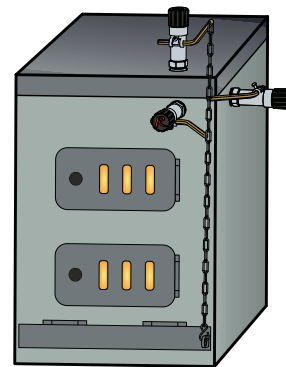

Working positions of RT4 regulator.

Thanks to the many versions and many working positions shown in the fig., the regulator can be easily mounted on any current boiler.

MODIFIED VARIANTS

RT4T differs in the sheath shape, RT4L and S were developed from the basic RT4 model but they differ in the lever length or shape.

RT4T - for boilers with a thicker mantle - **Code: 14138**

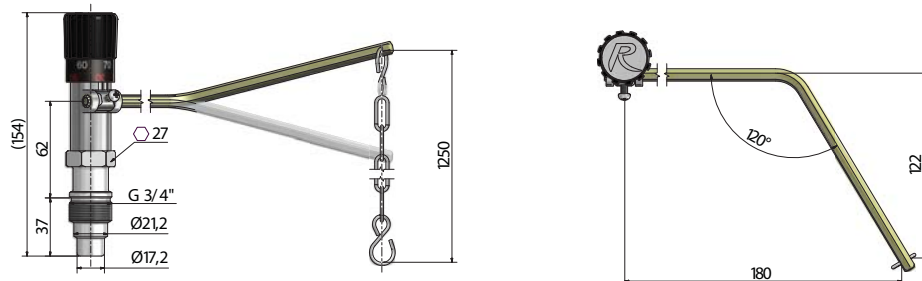

RT4L - with a longer lever - **Code: 14743**

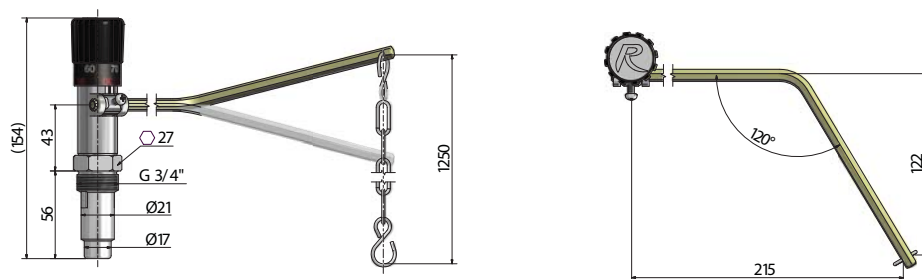

RT4S - with a right-angled lever, 313 mm distance - **Code: 14716**

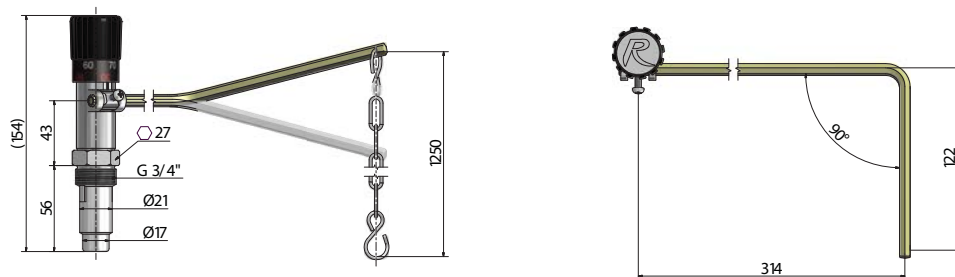

Utility model granted



